



# HAM-LET COMPRESSION TUBE FITTINGS

1/16" THROUGH 2" | 2 MM THROUGH 50 MM

## LET-LOK<sup>®</sup>



Platinum Natural Gas Solutions

[www.ptngs.com](http://www.ptngs.com)

[info@ptngs.com](mailto:info@ptngs.com) 484.897.0345

## LET-LOK HOW IT WORKS

The **LET-LOK** tube fitting is a mechanism used both to seal and to grip tubing. The mechanical advantage and geometry of this kind of fitting produces a leak-tight assembly.

To assemble, simply insert the tube into the complete assembly until the tube bottoms out against the shoulder of the fitting body (1). The two ferrules are driven forward between the nut (4) and fitting body using the mechanical force created by rotating the nut clockwise. The back ferrule (3) is driven against the tapered rear of the front ferrule (2). The front ferrule is driven by force into the tapered mouth of the body.

The rear ferrule is swaged radially inwards on the tube while lifting the front ferrule out to form a full-faced seal on the tapered surface of the body.

The one and one quarter turn of the nut from the hand-tight position ensures consistent drive of the sealing members. This ensures an effective seal against high-pressure as well as ultra-high-vacuum conditions.

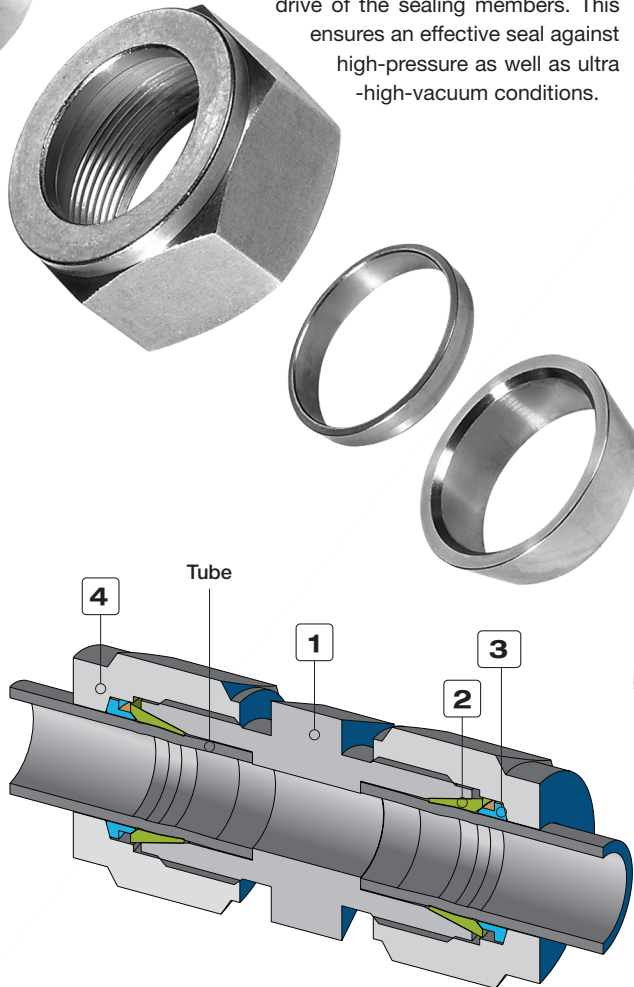

**LET-LOK**® TUBE FITTINGS CONSIST OF FOUR PARTS:  
1. BODY 2. FRONT FERRULE 3. BACK FERRULE 4. NUT

## LET-LOK TUBE FITTINGS DESCRIPTION

UCT Fluid Solutions produces high quality tube and pipe fittings in various materials for high-pressure applications.

As a result of tremendous efforts in research and development during the last five decades, UCT Fluid Solutions has gained an excellent reputation as a leading manufacturer of high-pressure instrumentation products. The **LET-LOK** range of connectors developed to fill the rapidly increasing demand for tube fittings suitable for high-pressure use in environments such as petrochemical, fluid, power, nuclear, electronic and other major industrial settings.

**LET-LOK** tube fittings were carefully manufactured to withstand the persistent demands for high-performance fluid systems. Each one passed a stringent tolerance test for high pressure, impulse, vibration, vacuum and temperature. These precision-machined fittings are manufactured to accurate standards, employing the most state-of-the-art computerized automation. All **LET-LOK** fittings are backed by our commitment to the highest quality-control standards and skilled craftsmanship.

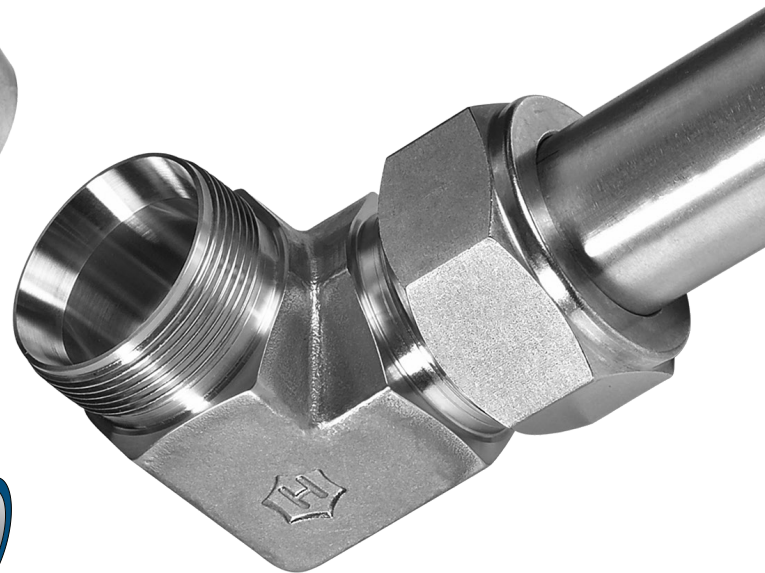

# LET-LOK FITTINGS INSTALLATION INSTRUCTIONS

LET-LOK® fittings are assembled and supplied finger tight. Disassembly before use can allow the entry of dirt or other particles.



## Insert the tubing into the LET-LOK fitting

Check that the tube rests firmly on the fitting shoulder and that the nut is finger tight. At this point it is recommended that a scribe mark be drawn on the hex of the nut extending onto the fitting body. This mark will serve as an indicator for the starting point and proper pull-up.

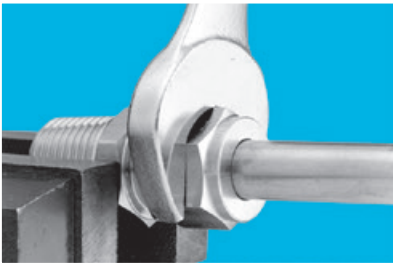

## Tighten the nut

1-1/4 turns of the nut are required for 1/4" (6 mm) and higher (see Fig. A). 3/4 turn of the nut is required for 3/16" (4 mm) and lower (see Fig. B).

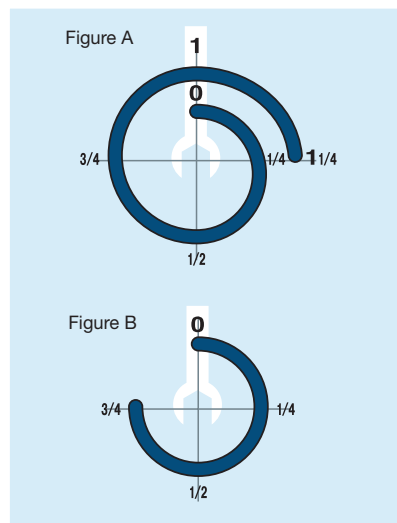

## REASSEMBLY INSTRUCTIONS

LET-LOK connections may be disconnected and remade repeatedly without the loss of the leak tight seal.

1. Before disconnecting, mark the position of the nut in relation to the fitting body.
2. To reassemble, use a wrench to tighten the nut to the original position.
3. Tighten slightly with a wrench until a slight rise in torque is felt.

## TUBE CUTTING

Two different methods can be used to cut tubes

1. Tube Cutter
2. Hacksaw

## TUBE CUTTER

To attain a leak free connection, the tubing must be cut squarely. A good quality tube cutter with an appropriate blade for tubing material is recommended. Do not try to reduce the time of cutting by taking deep cuts with each turn of the cutter. This will work harden the tube.

The end of the tube must be deburred to avoid damage to the fitting and to ensure that the tube reaches the bottom of the fitting.

## HACKSAW CUTTING

In order to cut the tube with a hacksaw and obtain square ends, the tube must be cut with guide blocks.

This method of cutting necessitates deburring of the tube ends.

## Warning

Do not hold the tube in a vise in the place where it will be inserted into the fitting (the vise will leave a mark on the tube that may cause leaks and ovality).

## TUBE HANDLING

Scratches on the tube might cause leaks. It is, therefore, important to handle the tube carefully to reduce the risk of leaks.

## PRECAUTIONS

1. Tubes must not be dragged on the floor.
2. Do not drag tubes out of the tubing.

## COPPER TUBING

If using copper tubing from a roll, hold the end of the tube and roll the roll outwards allowing the tubing to lie on a flat surface.

## INSPECTION GAUGE

**Use: This is a "No-Go" gauge and should be used as follows:**

1. Make up the fitting according to the following instructions:  
1/4 inch (6mm), 3/8 inch, 1/2 inch (12mm) make up 1-1/4 turns from the finger tight position.
2. Check gap between nut and body using the appropriate sized gauge.  
If the gauge slides easily into the gap, tighten the nut further until gauge cannot enter the gap.

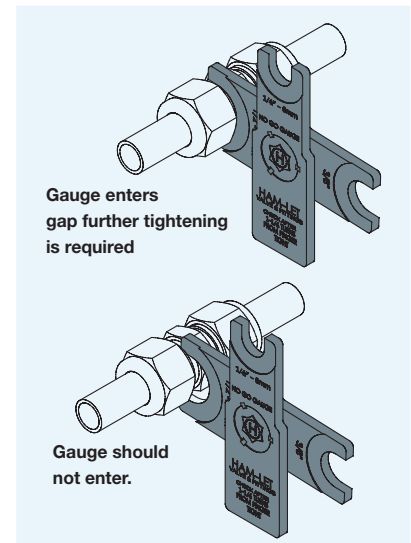

For Gauge Ordering Information, see page 98.



# LET-LOK FITTINGS INSTALLATION INSTRUCTIONS

## PHYSICAL DIFFERENCES AND MARKINGS

### LET-LOK® METRIC FITTINGS:

**Tee & Elbow:** (see Fig. 1)

**Body marked:** MM

**Straight Connectors:** (see Fig. 2)

**Body:** Stepped shoulder

**Marked:** LET-LOK 316 AV1<sup>(2)</sup>

**Nut:** (see Figs.1 & 2) Stepped shoulder

**Marked:** LET-LOK 316 6M<sup>(1)</sup> SD8<sup>(2)</sup>

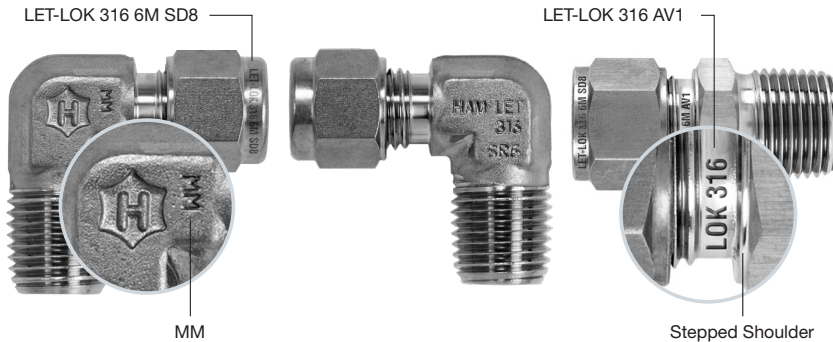

Fig. 1  
Back side

Fig. 1  
Front side

Fig. 2  
Stepped Shoulder

<sup>(1)</sup> Tube O.D. <sup>(2)</sup> Material Batch

### LET-LOK® INCH FITTINGS:

**Tee & Elbow:** (See Fig. 3)

**Straight Fittings:** (see Fig. 4)

**Body:** Shoulder marked:

LET-LOK 316 AV2<sup>(2)</sup>

**Nut:** (See Fig. 3 & 4): Shoulder marked

LET-LOK 316 1/2<sup>(1)</sup> BU2<sup>(2)</sup>

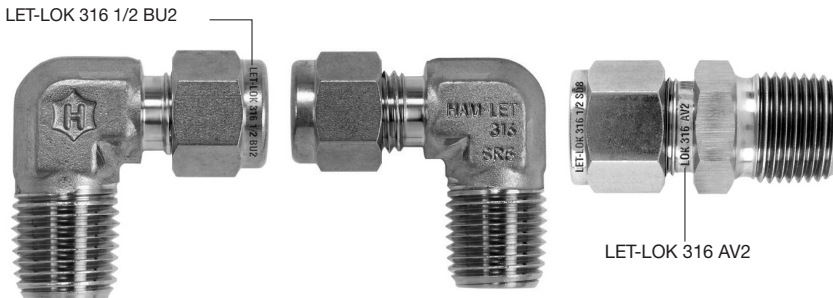

Fig. 3  
Back side

Fig. 3  
Front side

Fig. 4

<sup>(1)</sup> Tube O.D. <sup>(2)</sup> Material Batch

## TUBING DATA FOR LET-LOK® FITTINGS

In order to assure maximum fitting reliability and performance, great care should be given when selecting the tubing for each application.

## TUBE SELECTION

Four variables must be considered when ordering a tube for use with LET-LOK fittings:

1. Material
2. Tube wall thickness
3. Tube surface finish
4. Tube hardness

Tubing should comply with standard ASTM A213 or ASTM A269, be seamless and fully annealed. The tube must be free of scratches and suitable for bending and flaring.

## TUBE O.D. TOLERANCES

1/16" - 1/8"	} ±	0.003"
2mm - 3 mm		0.076 mm
3/16" - 1 1/4"	} ±	0.005"
4mm - 25 mm		0.127 mm
1 1/2" - 2"	} ±	0.006"
38mm - 50 mm		0.152 mm

The ovality of twice the O.D. tolerance is not suitable for LET-LOK fittings. The tube must be reasonably round.

The ends of the tube must be free of burrs.  
Tubing hardness: The hardness of the tube must be lower than the hardness of the fitting material.

The hardness must not exceed Rockwell 90 HRB (200HV).

## HIGH SAFETY

In applications where severe conditions and high pressure exist, we recommend the following installation procedures:

1. Check that the nut is finger tight
2. Fully insert the tube (up to the shoulder)
3. Rotate the nut with a wrench until the tube does not rotate freely
4. Mark the position of the nut
5. Rotate the nut 1-1/4 turns

This method ensures that even if the tube O.D. is at the minimum tolerance, the ferrules will be in contact with the tube for the full 1-1/4 rotation



**TABLE 1: STAINLESS STEEL INCH TUBING**

Tubing O.D. inch	WALL THICKNESS OF TUBE IN INCHES															
	0.010	0.012	0.014	0.016	0.020	0.028	0.035	0.049	0.065	0.083	0.095	0.109	0.120	0.134	0.156	0.188
	Working pressure (psi)															
1/16	5600	6860	8150	9480	11890											
1/8						8550	10730									
3/16						5500	7100	10150								
1/4						4100	5200	7600	10150							
5/16							4100	5900	7975							
3/8							3350	4850	6525							
1/2							2650	3750	5150	6525						
5/8								2950	4050	5250	5945					
3/4								2450	3350	4250	4950	5655				
7/8								2050	2850	3650	4250	4843				
1									2100	2700	3200	3700	3987			
1 1/4										2400	2800	3300	3600	4100	4785	
1 1/2											2300	2700	3000	3400	4000	4785
2												2000	2200	2500	2900	3600

Annealed 304 or 316 stainless steel tubing complying with ASTM A213, A269 or equivalent specifications. For metal temp. from -20°F - 100°F (-29°C - 37°C).

Suggested ordering information: Fully annealed high quality (Type 304 or 316) stainless steel hydraulic tubing ASTM A269 or A213 or equivalent, seamless or welded and drawn with a hardness of 90HRB (200HV) or less. Tubing should be without scratches and suitable for flaring and bending.

**TABLE 2: STAINLESS STEEL METRIC TUBING**

Tubing O.D. mm	WALL THICKNESS OF TUBE IN MM														
	0.8	1.0	1.2	1.5	1.8	2.0	2.2	2.5	2.8	3.0	3.5	4.0	4.5	5.0	
	Working pressure (bar)														
3	670														
6	310	420	540	710											
8		310	390	520											
10		240	300	400	510										
12		200	250	330	410	470									
14		160	200	270	340	380	430								
15		150	190	250	310	360	400								
16			170	230	290	330	370	400							
18			150	200	260	290	320	370							
20			140	180	230	260	290	330	380						
22			120	160	200	230	260	300	340						
25					180	200	230	260	290	320					
30					170	180	210	240	260	310					
32					160	170	200	220	240	290	330				
38							140	160	190	200	240	270	310		
50										150	180	210	240	270	

Annealed 304 or 316 stainless steel tubing complying with ASTM A213, A269 or equivalent specifications. For metal temp. from -20°F - 100°F (-29°C - 37°C).

Suggested ordering information: Fully annealed high quality (Type 304 or 316) stainless steel hydraulic tubing ASTM A269 or A213 or equivalent, seamless or welded and drawn with a hardness of 90HRB (200HV) or less. Tubing should be without scratches and suitable for flaring and bending.

**Working pressure for seamless tubing;**  
 Multiply pressure rating by .80 for single welded tubing.  
 Multiply pressure rating by .85 for double welded tubing.

**NOTE:** The system designer and user have the sole responsibility to select products suitable for their special application requirements and to ensure the proper installation, operation and maintenance of the product. Please consider application details, material compatibility and product ratings when making your selection. Improper selection or use of products can cause property damage or personal injury.

# TUBING DATA

**TABLE 3: COPPER TUBING WALL THICKNESS OF TUBE IN INCHES**

Tubing O.D.		0.028	0.035	0.049	0.065	0.083	0.095	0.109	0.120
mm	inch								
2	1/8	2700	3600						
3	3/16	1800	2300	3400					
6	1/4	1300	1600	2500	3500				
8	5/16		1300	1900	2700				
10	3/8		1000	1600	2200				
12	1/2		800	1100	1600	2100			
16	5/8			900	1200	1600	1900		
20	3/4			700	1000	1300	1500	1800	
22	7/8			600	800	1100	1300	1500	
25	1			500	700	900	1100	1300	1500

Annealed copper seamless tubing complying with ASTM B68 and ASTM B75 specified in temper designation 060. Based on ultimate tensile strength of 30,000 psi (2067 bar). For metal temperatures from -20°C to 37°C). Suggested ordering information: High quality soft annealed seamless copper tubing ASTM B75 or equivalent.

**TABLE 4: FACTORS USED TO DETERMINE ALLOWABLE PRESSURE AT HIGHER TEMPERATURES**

F°	C°	A.I.S.I. 316	Copper
200	93	1	0.80
400	204	0.96	0.50
600	316	0.85	-
800	427	0.79	-
1000	538	0.76	-

To determine allowable pressure at higher temperatures, multiply allowable working pressure from Tables 1 & 2 & 3 by factor shown in Table 4. For example, the allowable pressure for Type 316 stainless steel, size 1/2" OD x .049" wall at 800°F (427°C) would be equivalent to 3750 psi x 0.79 = 2962.5 psi.

**TABLE 5: GAS APPLICATION TUBING**

INCH		METRIC	
Tubing O.D.	Min. Nominal Wall Thickness	Tubing O.D.	Min. Nominal Wall Thickness
-	-	14 mm	1.2 mm
-	-	15 mm	1.5 mm
-	-	16 mm	1.5 mm
1/2	0.049	18 mm	1.5 mm
5/8	0.065	20 mm	1.8 mm
3/4	0.065	22 mm	2.0 mm
7/8	0.083	25 mm	2.2 mm
1	0.083	30 mm	2.8 mm
1 1/4	0.109	32 mm	3.0 mm
1 1/2	0.134	38 mm	3.5 mm
2	0.188	50 mm	5.0 mm

Gases are characterized by small molecules which can escape through the smallest leak path. For gas applications, we recommend tubing with greater wall thickness. Table 5 shows the recommended minimum wall thickness to ensure performance.

**NOTE:** For your safety, the system designer and user have the sole responsibility to select products suitable for their special application requirements and to ensure the proper installation, operation and maintenance of the product. Please consider application details, material compatibility and product ratings when making your selection. Improper selection or use of products can cause property damage or personal injury.

**MATERIAL**

Stainless steel straight fittings: material is stainless steel 316L in accordance with ASTM A479, ASTM A276 and DIN EN10272.

Stainless steel shaped fittings: material is stainless steel 316L in accordance with ASTM A182 and DIN EN10122-5.

**Let-Lok® Fitting Vacuum Rating**

Inboard Helium Leak Rate of 1x10<sup>-9</sup> atm cc/sec

**Pressure Ratings for Tube Fittings**

To ensure leak-tight systems, it is important to carefully select high-quality tubing (see page 5 - allowable working pressure).

**Pipe End Thread (NPT and ISO 7) Pressure Ratings**

Allowable pressure for male and female tapered pipe thread ends: stainless steel 316 and brass.

**TABLE 6: PRESSURE RATINGS**

NPT / ISO PIPE SIZE	Stainless Steel 316		Brass	
	Male	Female	Male	Female
inch	psi			
1/16	11000	6700	5500	3300
1/8	10000	6500	5000	3200
1/4	8000	6600	4000	3300
3/8	7800	5300	3900	2600
1/2	7700	4900	3800	2400
3/4	7300	4600	3600	2300
1	5300	4400	2600	2200
1 1/4	6000	5000	3000	2500
1 1/2	5000	4600	2500	2300
2	3900	3900	1900	1900

Note: If the pressure on the LET-LOK® end is higher than the pipe side, then the pipe side needs a heavier wall thickness of the tapered pipe thread side.

**PRESSURE RATINGS FOR END FITTINGS PER SAE J1926 (LOB) AMBIENT TEMPERATURE**

Pressure ratings are based on SAE J1926 at ambient temperature.

**TABLE 7: PRESSURE RATINGS**

(LOB) SAE J1926 Thread Size	Stainless Steel 316	
	Nonpositionable	Positionable
inch	psi	
5/16 - 24	4568	4568
7/16 - 20	4568	4568
1/2 - 20	4568	4568
9/16 - 18	4568	3626
3/4 - 16	4568	3626
7/8 - 14	3626	2900
1 1/16 - 12	3626	2900
1 3/16 - 12	2900	2320
1 5/16 - 12	2900	2320
1 5/8 - 12	2320	1813
1 7/8 - 12	2320	1813
2 1/2 - 12	1813	1450

Note: 37° FLARE (AN) and LO ends can have lower pressure.

**O-seal poessure ratings**

Stainless steel 316 O-seal fittings up to 1" and 25 mm are rated to 3000 psi.

**Positionable, ISO/BSP parallel thread (G) pressure ratings**

Pressure ratings are at surrounding temperature.

**TABLE 8: PRESSURE RATINGS**

(G) ISO / BSPP Male Pipe Size	Stainless Steel 316
inch	psi
1/8	4568
1/4	4568
3/8	4568
1/2	2320
3/4	2320
1	2320



# LET-LOK® INDEX

**BACK FERRULE**  
760 LB



10

**FRONT FERRULE**  
760 LF



10

**TUBE INSERT**  
760 LI



11

**NUT**  
761 L



11

**UNION**  
762 L



12

**REDUCING UNION**  
763 L



13

**UNION TEE**  
764 L



15

**REDUCING TEE**  
764 LR



16

**UNION ELBOW**  
765 L



18

**REDUCING UNION ELBOW**  
765 LR



19

**FEMALE CONNECTOR**  
766 L



20

**FEMALE CONNECTOR**  
766 LR



22

**FEMALE CONNECTOR**  
766 LG



24

**REDUCER**  
767 LT



25

**PORT CONNECTOR**  
767 LP



28

**REDUCING PORT CONNECTOR**  
767 LM



29

**MALE CONNECTOR**  
768 L



30

**MALE CONNECTOR**  
768 LR



33

**MALE CONNECTOR**  
768 LG



35

**MALE CONNECTOR**  
768 LOK



37

**MALE CONNECTOR**  
768 LOB



38

**MALE CONNECTOR**  
768 LOP



40

**MALE CONNECTOR**  
768 LO



40

**MALE PIPE WELD CONNECTOR**  
768 LN



41

**TUBE SOCKET WELD UNION**  
768 LW



42

**SANITARY FLANGE**  
768 LSF



43

**TRI CLAMPE FITTINGS**  
768 LTC



43

**MALE ELBOW**  
769 L



44

**MALE ELBOW**  
769 LA 45°



46

**MALE ELBOW**  
769 LR



47

**MALE ELBOW POS**  
769 LOB



49

**MALE ELBOW POS**  
769 LG



51

**MALE ELBOW POS**  
769 LOB 45°



52

**MALE ELBOW POS °45**  
769 LG 45°



52

**MALE PIPE WELD ELBOW**  
769 LN



53

**TUBE SOCKET WELD ELBOW**  
769 LW



53

**REDUCING ELBOW**  
769 LT



54

**FEMALE ELBOW**  
770 L



55

**MALE RUN TEE**  
771 L



56

**MALE RUN TEE POS**  
771 LOB



57

**MALE RUN TEE POS**  
771 LG



57

**FEMALE RUN TEE**  
771 LF



58

**MALE BRANCH TEE**  
772 L



59

**MALE BRANCH TEE POS**  
772 LOB



60

**MALE BRANCH TEE POS**  
772 LG



61

**FEMALE BRANCH TEE**  
772 LF



62

**BULKHEAD UNION**  
774 L



63

**BULKHEAD FEMALE CONNECTOR**  
774 LF



64

**BULKHEAD REDUCER**  
774 LT



64

**BULKHEAD MALE CONNECTOR**  
774 LM



65

**BULKHEAD REDUCING UNION**  
775 L



66

**BULKHEAD RETAINER**  
774 LSS



67

**UNION CROSS**  
7102 L



68

**CAP**  
7108 L



69

**PLUG**  
7121 L



70

**PLUG WITH LANYARD**  
7121 LANYARD



71

**FEMALE ADAPTER TUBE TO PIPE**  
739 LF



72

**MALE ADAPTER TUBE TO PIPE**  
739 LM



74

**MALE ADAPTER TUBE TO PIPE**  
739 LMR



76

**MALE ADAPTER TUBE TO PIPE**  
739 LMG



77

**WELD ADAPTER TUBE TO PIPE**  
739 LN



78

**SOCKET WRDL ADAPTER**  
739 LW



78

**MALE ADAPTER TUBE TO PIPE**  
739 LMOB



79

**LET-LOK TO AN ADAPTER**  
761 LFL



80

**LET-LOK TO AN UNION**  
762 LFL



80

**LET-LOK TO AN BULKHEAD UNION**  
774 LFL



80

**MALE ADAPTER TUBE TO AN**  
739 LTFL



81

**PARALLEL THREADS SEALING**



82

**MALE NUT**  
961 L



84

**UNION**  
962 L



84

**REDUCING UNION**  
963 L



84

**UNION TEE**  
964 L



84

**MALE CONNECTOR**  
768 LC



85

**ALLOY 400 NICKEL COPPER ALLOY 400/405 CONNECTORS**

86

**ALLOY C-276 CONNECTORS**

88

**SUPER DUPLEX 2507 CONNECTORS**

90

**ALLOY 825 CONNECTORS**

92

**ALLOY 254 CONNECTORS**

94

**UNION DIELECTRIC 762 L DIELECTRIC**



96

**ACCESSORIES**

Preassembly tool, tube holders, stop collar

98

## LET-LOK MATERIAL DESCRIPTION

EXAMPLE:

768L

### MATERIAL DESCRIPTION

**SS** - Stainless Steel 316  
**B** - Brass

1/4

X

1/4

All orders should include material description and ordering information (see product table).

## 760 LB BACK FERRULE

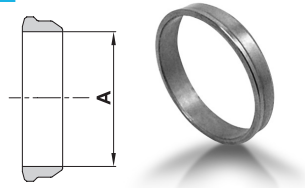

### METRIC

Ordering Information	A Tube O.D.
	mm
760LB _ 2	2
760LB _ 3	3
760LB _ 4	4
760LB _ 6	6
760LB _ 8	8
760LB _ 10	10
760LB _ 12	12
760LB _ 14	14
760LB _ 15	15
760LB _ 16	16
760LB _ 18	18
760LB _ 20	20
760LB _ 22	22
760LB _ 25	25
760LB _ 38 *	38
760LB _ 50 *	50

\*Without Ferrule bar.

### INCH

Ordering Information	A Tube O.D.	
	inch	mm
760LB _ 1/16	1/16	1.58
760LB _ 1/8	1/8	3.17
760LB _ 3/16	3/16	4.76
760LB _ 1/4	1/4	6.35
760LB _ 5/16	5/16	7.93
760LB _ 3/8	3/8	9.52
760LB _ 1/2	1/2	12.70
760LB _ 5/8	5/8	15.87
760LB _ 3/4	3/4	19.05
760LB _ 7/8	7/8	22.22
760LB _ 1	1	25.40
760LB _ 1 1/4 *	1 1/4	31.75
760LB _ 1 1/2 *	1 1/2	38.10
760LB _ 2 *	2	50.80

## 760 LF FRONT FERRULE

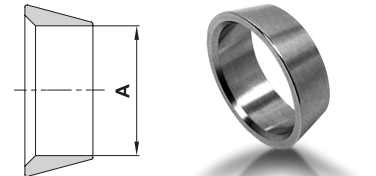

### METRIC

Ordering Information	A Tube O.D.
	mm
760LF _ 2	2
760LF _ 3	3
760LF _ 4	4
760LF _ 6	6
760LF _ 8	8
760LF _ 10	10
760LF _ 12	12
760LF _ 14	14
760LF _ 15	15
760LF _ 16	16
760LF _ 18	18
760LF _ 20	20
760LF _ 22	22
760LF _ 25	25
760LF _ 38 *	38
760LF _ 50 *	50

\*Without Ferrule bar.

### INCH

Ordering Information	A Tube O.D.	
	inch	mm
760LF _ 1/16	1/16	1.58
760LF _ 1/8	1/8	3.17
760LF _ 3/16	3/16	4.76
760LF _ 1/4	1/4	6.35
760LF _ 5/16	5/16	7.93
760LF _ 3/8	3/8	9.52
760LF _ 1/2	1/2	12.70
760LF _ 5/8	5/8	15.87
760LF _ 3/4	3/4	19.05
760LF _ 7/8	7/8	22.22
760LF _ 1	1	25.40
760LF _ 1 1/4 *	1 1/4	31.75
760LF _ 1 1/2 *	1 1/2	38.10
760LF _ 2 *	2	50.80

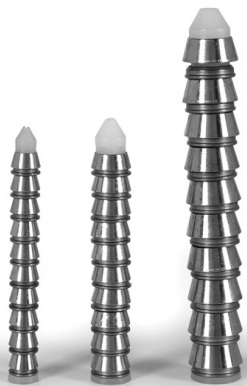

### FERRULE SETS

All LET-LOK Ferrules are available as sets. Ferrule sets simplify stocking and assembly. Ferrule sets prevent damage of single ferrules during shipping.

The back and front ferrules are arranged as pairs in the set; ready for easy assembly.



### FERRULE & NUT SETS

All LET-LOK Ferrules and nuts are available as sets. Ferrule sets simplify stocking and assembly. Ferrule sets prevent damage of single ferrules during shipping.

The front + back ferrule and nut are arranged and ready for easy assembly.

### Ordering Information for Ferrule Sets / Ferrule and nut Sets

EXAMPLE: 760      LS      SS      1/4

<b>LS</b> = Ferrule Sets	<b>SS</b> = Stainless Steel 316	<b>Tube O.D.</b>
<b>LNS</b> = Ferrule and nuts sets	<b>B</b> = Brass	The O.D. size is always the first to be described.
	<b>T</b> = PTFE	

Dimensions are for reference only and subject to change without notice.



## 760 LI TUBE INSERT

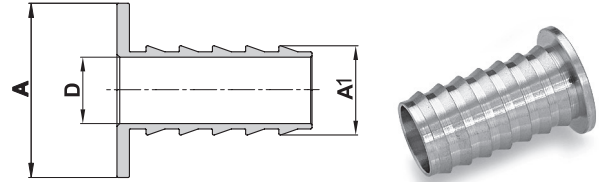

### METRIC

Ordering Information	A Tube O.D.	A1 Tube I.D.	D
	mm	mm	mm
760LI _ 6 X 4	6	4	2.8
760LI _ 8 X 6	8	6	4.4
760LI _ 10 X 8	10	8	6.4
760LI _ 12 X 8	12	8	6.4
760LI _ 12 X 10	12	10	8.3

### INCH

Ordering Information	A Tube O.D.		A1 Tube I.D.		D	
	inch	mm	inch	mm	inch	mm
760LI _ 3/16 X 1/8	3/16	4.76	1/8	3.17	.09	2.30
760LI _ 1/4 X 1/8	1/4	6.35	1/8	3.17	.09	2.30
760LI _ 1/4 X 0.17	1/4	6.35	.17	4.32	.11	2.70
760LI _ 1/4 X 3/16	1/4	6.35	3/16	4.76	.12	3.10
760LI _ 5/16 X 1/8	5/16	7.93	1/8	3.17	.09	2.30
760LI _ 5/16 X 3/16	5/16	7.93	3/16	4.76	.12	3.00
760LI _ 5/16 X 1/4	5/16	7.93	1/4	6.35	.18	4.65
760LI _ 3/8 X 3/16	3/8	9.52	3/16	4.76	.12	3.10
760LI _ 3/8 X 1/4	3/8	9.52	1/4	6.35	.18	4.65
760LI _ 1/2 X 1/4	1/2	12.70	1/4	6.35	.18	4.65
760LI _ 1/2 X 3/8	1/2	12.70	3/8	9.52	.31	7.80
760LI _ 5/8 X 3/8	5/8	15.87	3/8	9.52	.31	7.80
760LI _ 5/8 X 1/2	5/8	15.87	1/2	12.70	.44	11.10
760LI _ 3/4 X 1/2	3/4	19.05	1/2	12.70	.44	11.10
760LI _ 3/4 X 5/8	3/4	19.05	5/8	15.87	.56	14.20
760LI _ 1 X 3/4	1	25.40	3/4	19.05	.69	17.50

## 761 L NUT

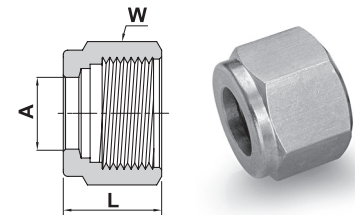

### METRIC

Ordering Information	A Tube O.D.	W Hex. Flat	L
	mm	mm	mm
761L _ 2	2	12	11.9
761L _ 3	3	12	11.9
761L _ 4	4	12	11.9
761L _ 6	6	14	12.7
761L _ 8	8	16	13.5
761L _ 10	10	19	15.1
761L _ 12	12	22	17.4
761L _ 14	14	25	17.4
761L _ 15	15	25	17.4
761L _ 16	16	25	17.4
761L _ 18	18	30	17.4
761L _ 20	20	32	17.4
761L _ 22	22	32	17.4
761L _ 25	25	38	20.6
761L _ 38	38	60	40.6
761L _ 50	50	inch 3	54.0

### INCH

Ordering Information	A Tube O.D.		W Hex. Flat	L	
	inch	mm	inch	inch	mm
761L _ 1/16	1/16	1.58	5/16	.31	7.87
761L _ 1/8	1/8	3.17	7/16	.47	11.93
761L _ 3/16	3/16	4.76	1/2	.47	11.93
761L _ 1/4	1/4	6.35	9/16	.50	12.70
761L _ 5/16	5/16	7.93	5/8	.53	13.46
761L _ 3/8	3/8	9.52	11/16	.56	14.22
761L _ 1/2	1/2	12.70	7/8	.69	17.52
761L _ 5/8	5/8	15.87	1	.69	17.52
761L _ 3/4	3/4	19.05	1 1/8	.69	17.52
761L _ 7/8	7/8	22.22	1 1/4	.69	17.52
761L _ 1	1	25.40	1 1/2	.81	20.57
761L _ 1 1/4	1 1/4	31.75	1 7/8	1.25	31.75
761L _ 1 1/2	1 1/2	38.10	2 1/4	1.50	38.10
761L _ 2	2	50.80	3	2.06	52.32

"D" - Dimension is minimum opening. Dimensions are for reference only and subject to change without notice.

# 762 L UNION

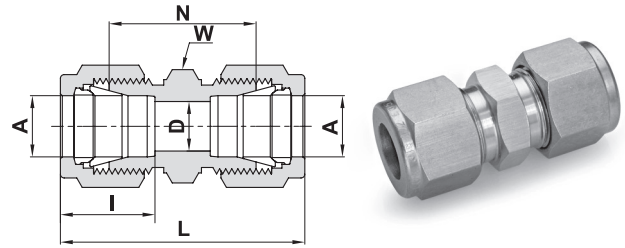

## TUBE (METRIC) TO TUBE (METRIC)

Ordering Information	A Tube O.D.		D		W Hex. Flat	N		L		I
	mm	mm	mm	mm	mm	mm	mm	mm	mm	mm
762L _ 2	2	1.7	12	22.4	35.6	12.9				
762L _ 3	3	2.4	12	22.1	35.3	12.9				
762L _ 4	4	2.4	12	24.1	37.3	13.7				
762L _ 6	6	4.8	14	26.2	41.0	15.3				
762L _ 8	8	6.4	15	28.2	43.2	16.2				
762L _ 10	10	7.9	18	31.0	46.2	17.2				
762L _ 12	12	9.5	22	31.0	51.2	22.8				
762L _ 14	14	11.1	24	31.8	52.0	24.4				
762L _ 15	15	11.9	24	31.8	52.0	24.4				
762L _ 16	16	12.7	24	31.8	52.0	24.4				
762L _ 18	18	15.1	27	33.3	53.5	24.4				
762L _ 20	20	15.9	30	34.8	55.0	26.0				
762L _ 22	22	18.3	30	34.8	55.0	26.0				
762L _ 25	25	21.8	35	40.4	65.0	31.3				
762L _ 30	30*	26.2	46	49.5	92.7	39.6				
762L _ 32	32*	28.6	46	51.3	97.3	42				
762L _ 38	38*	33.7	55	58.4	114.0	49.4				
762L _ 50	*50	45.2	3 inch	71.7	146.0	65.0				

## TUBE (INCH) TO TUBE (INCH)

Ordering Information	A Tube O.D.		D		W Hex. Flat	N		L		I	
	inch	mm	inch	mm	inch	inch	mm	inch	mm	inch	mm
762L _ 1/16	1/16	1.58	.05	1.27	5/16	.69	17.52	.99	25.14	.34	8.6
762L _ 1/8	1/8	3.17	.09	2.28	7/16	.88	22.35	1.40	35.56	.50	12.7
762L _ 3/16	3/16	4.76	.12	3.04	7/16	.95	24.13	1.47	37.33	.54	13.7
762L _ 1/4	1/4	6.35	.19	4.82	1/2	1.03	26.16	1.61	40.89	.60	15.2
762L _ 5/16	5/16	7.93	.25	6.35	9/16	1.11	28.19	1.69	42.92	.64	16.2
762L _ 3/8	3/8	9.52	.28	7.11	5/8	1.19	30.22	1.77	44.95	.66	16.8
762L _ 1/2	1/2	12.70	.41	10.41	13/16	1.22	30.98	2.02	51.30	.90	22.9
762L _ 5/8	5/8	15.87	.50	12.70	15/16	1.25	31.75	2.05	52.07	.96	24.4
762L _ 3/4	3/4	19.05	.62	15.75	1 1/16	1.31	33.27	2.11	53.59	.96	24.4
762L _ 7/8	7/8	22.22	.72	18.28	1 3/16	1.37	34.80	2.17	55.11	1.02	25.9
762L _ 1	1	25.40	.88	22.35	1 3/8	1.59	40.38	2.55	64.77	1.23	31.2
762L _ 1 1/4	1 1/4*	31.75	1.09	27.70	1 3/4	1.89	48.00	3.63	92.20	1.62	41.2
762L _ 1 1/2	1 1/2*	38.10	1.34	34.00	2 1/8	2.11	53.60	4.25	107.95	1.97	50.0
762L _ 2	2*	50.80	1.81	45.97	2 3/4	2.94	74.67	5.88	149.35	2.66	67.6

\* Including low friction paste, paste (see page 98)

"D" - Dimension is minimum opening. Dimensions are for reference only and subject to change without notice.

# 763 L REDUCING UNION

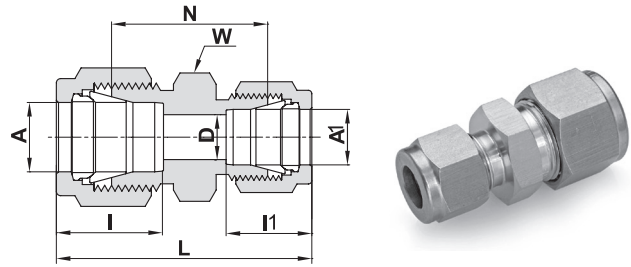

## TUBE (METRIC) TO TUBE (METRIC)

Ordering Information	A	A1	D	W Hex. Flat	N	L	I	I1
	Tube O.D.	Tube O.D.						
	mm	mm	mm	mm	mm	mm	mm	mm
763L_ 3 X 2	3	2	1.7	12	22.1	35.3	12.9	12.9
763L_ 6 X 2	6	2	1.7	14	24.6	38.6	15.3	12.9
763L_ 6 X 3	6	3	2.4	14	24.6	38.6	15.3	12.9
763L_ 6 X 4	6	4	2.4	14	25.4	39.4	15.3	13.7
763L_ 8 X 6	8	6	4.8	15	27.4	42.3	16.2	15.3
763L_ 10 X 6	10	6	4.8	18	29.5	44.5	17.2	15.3
763L_ 10 X 8	10	8	6.4	18	30.0	45.1	17.2	16.2
763L_ 12 X 6	12	6	4.8	22	29.5	47.0	22.8	15.3
763L_ 12 X 8	12	8	6.4	22	30.2	47.8	22.8	16.2
763L_ 12 X 10	12	10	7.9	22	31.0	48.7	22.8	17.2
763L_ 16 X 10	16	10	7.9	24	31.8	49.5	24.4	17.2
763L_ 16 X 12	16	12	9.5	24	31.8	52.0	24.4	22.8
763L_ 18 X 12	18	12	9.5	27	33.3	53.5	24.4	22.8
763L_ 25 X 18	25	18	15.1	35	38.6	61.0	31.3	24.4
763L_ 25 X 20	25	20	15.9	35	39.9	62.3	31.3	26.0
763L_ 30X18	30*	18	15.1	46	43.7	75.4	39.6	24.4
763L_ 30X20	30*	20	15.9	46	43.7	75.4	39.6	26
763L_ 30X25	30*	25	21.8	46	46.2	80.1	39.6	31.3
763L_ 32X18	32*	18	15.1	46	44.7	77.8	42	24.4
763L_ 32X20	32*	20	15.9	46	44.7	77.8	42	26
763L_ 32X25	32*	25	21.8	46	47	82.3	42	31.3
763L_ 38X30	38*	30*	26.2	55	55.8	105	49.4	39.6
763L_ 38 X 20	38*	20	15.9	55	49.8	87.5	49.4	26.0
763L_ 38 X 25	38*	25	21.8	55	55.5	95.4	49.4	31.3

## TUBE (METRIC) TO TUBE (INCH)

Ordering Information	A	A1	D	W Hex. Flat	N	L	I	I1
	Tube O.D.	Tube O.D.						
	mm	inch	mm	mm	mm	mm	mm	mm
763L_ 2 X 1/4	2	1/4	1.7	14	24.6	38.6	12.9	15.2
763L_ 3 X 1/8	3	1/8	2.4	12	22.1	35.2	12.9	12.7
763L_ 4 X 1/8	4	1/8	2.4	12	23.4	36.5	13.7	12.7
763L_ 4 X 1/4	4	1/4	2.4	14	25.4	39.4	13.7	15.2
763L_ 6 X 1/8	6	1/8	2.4	14	24.6	38.5	15.3	12.7
763L_ 6 X 1/4	6	1/4	4.8	14	26.2	41.0	15.3	15.2
763L_ 6 X 5/16	6	5/16	4.8	14	27.4	42.3	15.3	16.2
763L_ 8 X 1/8	8	1/8	2.4	15	25.7	39.8	16.2	12.7
763L_ 8 X 1/4	8	1/4	4.8	15	27.4	42.3	16.2	15.2
763L_ 8 X 3/8	8	3/8	6.4	16	29.5	44.3	16.2	16.8
763L_ 10 X 1/8	10	1/8	2.4	18	27.7	41.8	17.2	12.7

\* Including low friction paste, see page 98 "D" - Dimension is minimum opening. Dimensions are for reference only and subject to change without notice.

Cont'd next page



763 L

**REDUCING UNION** (Cont'd)

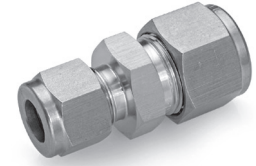
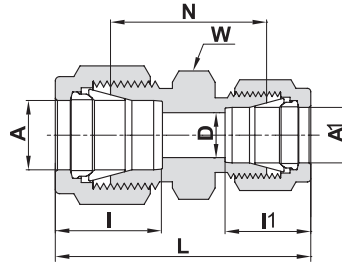

**TUBE (METRIC) TO TUBE (INCH)**

Ordering Information	A		A1		D		W		N		L		I		I1	
	Tube O.D.		Tube O.D.		mm		Hex. Flat		mm		mm		mm		mm	
	mm	inch	inch	mm	mm	mm	mm	mm	mm	mm	mm	mm	mm	mm	mm	mm
763L _ 10 X 1/4	10	1/4		4.8	18	29.5	44.5	17.2	15.2							
763L _ 10 X 5/16	10	5/16		6.4	18	30.0	45.1	17.2	16.2							
763L _ 10 X 3/8	10	3/8		7.1	18	31.0	45.9	17.2	16.8							
763L _ 12 X 5/16	12	5/16		6.4	22	30.2	47.8	22.8	16.2							
763L _ 12 X 3/8	12	3/8		7.1	22	31.0	48.4	22.8	16.8							
763L _ 12 X 1/2	12	1/2		9.5	22	31.0	51.2	22.8	22.9							
763L _ 15 X 1/2	15	1/2		10.3	24	31.8	52.0	24.4	22.9							
763L _ 16 X 5/8	16	5/8		12.7	24	31.8	52.0	24.4	24.4							
763L _ 18 X 3/4	18	3/4		15.1	27	33.3	53.5	24.4	24.4							

\* Including low friction paste, see page 101 "D" - Dimension is minimum opening. Dimensions are for reference only and subject to change without notice.

**TUBE (INCH) TO TUBE (INCH)**

Ordering Information	A		A1		D		W		N		L		I		I1	
	Tube O.D.		Tube O.D.		inch		Hex. Flat		inch		inch		inch		inch	
	inch	mm	inch	mm	inch	mm	inch	mm	inch	mm	inch	mm	inch	mm	inch	mm
763L _ 1/8 X 1/16	1/8	3.17	1/16	1.58	.05	1.27	7/16	.81	20.57	1.22	30.98	.50	12.7	.34	8.6	
763L _ 3/16 X 1/16	3/16	4.76	1/16	1.58	.05	1.27	7/16	.86	21.84	1.27	32.26	.54	13.7	.34	8.6	
763L _ 3/16 X 1/8	3/16	4.76	1/8	3.17	.09	2.28	7/16	.92	23.36	1.44	36.57	.54	13.7	.50	12.7	
763L _ 1/4 X 1/16	1/4	6.35	1/16	1.58	.05	1.27	1/2	.91	23.11	1.35	34.29	.60	15.2	.34	8.6	
763L _ 1/4 X 1/8	1/4	6.35	1/8	3.17	.09	2.28	1/2	.97	24.63	1.52	38.60	.60	15.2	.50	12.7	
763L _ 1/4 X 3/16	1/4	6.35	3/16	4.76	.12	3.04	1/2	1.00	25.40	1.55	37.37	.60	15.2	.54	13.7	
763L _ 5/16 X 1/8	5/16	7.93	1/8	3.17	.09	2.28	9/16	1.01	25.65	1.56	39.62	.64	16.2	.50	12.7	
763L _ 5/16 X 1/4	5/16	7.93	1/4	6.35	.19	4.82	9/16	1.08	27.43	1.66	42.16	.64	16.2	.60	15.2	
763L _ 3/8 X 1/16	3/8	9.52	1/16	1.58	.05	1.27	5/8	1.00	25.40	1.44	36.58	.66	16.8	.34	8.6	
763L _ 3/8 X 1/8	3/8	9.52	1/8	3.17	.09	2.28	5/8	1.06	26.92	1.61	40.89	.66	16.8	.50	12.7	
763L _ 3/8 X 1/4	3/8	9.52	1/4	6.35	.19	4.82	5/8	1.12	28.44	1.70	43.18	.66	16.8	.60	15.2	
763L _ 3/8 X 5/16	3/8	9.52	5/16	7.93	.25	6.35	5/8	1.16	29.46	1.74	44.19	.66	16.8	.64	16.2	
763L _ 1/2 X 1/8	1/2	12.70	1/8	3.17	.09	2.28	13/16	1.12	28.44	1.78	45.21	.90	22.9	.50	12.7	
763L _ 1/2 X 1/4	1/2	12.70	1/4	6.35	.19	4.82	13/16	1.16	29.46	1.85	46.99	.90	22.9	.60	15.2	
763L _ 1/2 X 3/8	1/2	12.70	3/8	9.52	.28	7.11	13/16	1.22	30.98	1.91	48.51	.90	22.9	.66	16.8	
763L _ 5/8 X 3/8	5/8	15.87	3/8	9.52	.28	7.11	15/16	1.25	31.75	1.94	49.27	.96	24.4	.66	16.8	
763L _ 5/8 X 1/2	5/8	15.87	1/2	12.70	.41	10.41	15/16	1.25	31.75	2.05	52.07	.96	24.4	.90	22.9	
763L _ 3/4 X 1/4	3/4	19.05	1/4	6.35	.19	4.82	1 1/16	1.25	31.75	1.94	49.28	.96	24.4	.60	15.2	
763L _ 3/4 X 3/8	3/4	19.05	3/8	9.52	.28	7.11	1 1/16	1.31	33.27	2.00	50.80	.96	24.4	.66	16.8	
763L _ 3/4 X 1/2	3/4	19.05	1/2	12.70	.41	10.41	1 1/16	1.31	33.27	2.11	53.59	.96	24.4	.90	22.9	
763L _ 3/4 X 5/8	3/4	19.05	5/8	15.87	.50	12.70	1 1/16	1.31	33.27	2.11	53.59	.96	24.4	.96	24.4	
763L _ 1 X 1/2	1	25.4	1/2	12.70	.41	10.41	1 3/8	1.50	38.10	2.38	60.45	1.23	31.2	.90	22.9	
763L _ 1 X 3/4	1	25.4	3/4	19.05	.62	15.75	1 3/8	1.50	38.10	2.38	60.45	1.23	31.2	.96	24.4	

# 764 L UNION TEE

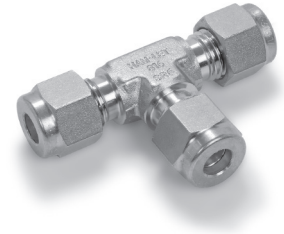
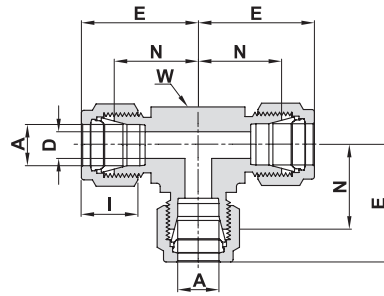

## ALL TUBE (METRIC)

Ordering Information	A Tube O.D.		D		W Wrench Flat		N		E		I	
	mm	mm	mm	mm	inch	mm	mm	mm	mm	mm	mm	mm
764L _ 2	2		1.7		3/8	9.5	15.7		22.3		12.9	
764L _ 3	3		2.4		3/8	9.5	15.7		22.3		12.9	
764L _ 4	4		2.4		1/2	12.7	18.8		25.4		13.7	
764L _ 6	6		4.8		1/2	12.7	19.6		27.0		15.3	
764L _ 8	8		6.4		5/8	15.9	22.4		29.9		16.2	
764L _ 10	10		7.9		11/16	17.5	23.9		31.5		17.2	
764L _ 12	12		9.5		13/16	20.6	25.9		36.0		22.8	
764L _ 14	14		11.1		15/16	23.8	28.7		38.8		24.4	
764L _ 15	15		11.9		15/16	23.8	28.7		38.8		24.4	
764L _ 16	16		12.7		15/16	23.8	28.7		38.8		24.4	
764L _ 18	18		15.1		1 1/16	27.0	29.7		39.8		24.4	
764L _ 20	20		15.9		1 3/8	34.9	34.5		44.6		26.0	
764L _ 22	22		18.3		1 3/8	34.9	34.5		44.6		26.0	
764L _ 25	25		21.8		1 3/8	34.9	36.8		49.1		31.3	
764L _ 30	*30		26.2		-	46	48.3		69.9		39.6	
764L _ 32	*32		28.6		-	46	49.3		72.3		42	
764L _ 38	*38		33.7		-	55.0	56.4		84.0		49.4	
764L _ 50	*50		45.2		2 3/4	69.9	68.9		106.0		65.0	

## ALL TUBE (INCH)

Ordering Information	A Tube O.D.		D		W Wrench Flat		N		E		I	
	inch	mm	inch	mm	inch	mm	inch	mm	inch	mm	inch	mm
764L _ 1/16	1/16	1.58	.05	1.27	3/8	9.5	.55	14.00	.70	17.80	.34	8.6
764L _ 1/8	1/8	3.17	.09	2.28	3/8	9.5	.62	15.74	.88	22.35	.50	12.7
764L _ 3/16	3/16	4.76	.12	3.04	1/2	12.7	.70	17.80	.96	24.40	.54	13.7
764L _ 1/4	1/4	6.35	.19	4.82	1/2	12.7	.77	19.55	1.06	26.90	.60	15.2
764L _ 5/16	5/16	7.93	.25	6.35	5/8	15.9	.88	22.35	1.17	29.71	.64	16.2
764L _ 3/8	3/8	9.52	.28	7.11	5/8	15.9	.91	23.11	1.20	30.48	.66	16.8
764L _ 1/2	1/2	12.70	.41	10.41	13/16	20.6	1.02	25.90	1.42	36.06	.90	22.9
764L _ 5/8	5/8	15.87	.50	12.70	15/16	23.8	1.13	28.70	1.53	38.90	.96	24.4
764L _ 3/4	3/4	19.05	.62	15.74	1 1/16	27.0	1.17	29.70	1.57	39.90	.96	24.4
764L _ 7/8	7/8	22.22	.72	18.29	1 3/8	34.9	1.36	34.54	1.76	44.70	1.02	25.9
764L _ 1	1	25.40	.88	22.35	1 3/8	34.9	1.45	36.83	1.93	49.00	1.23	31.2
764L _ 1 1/4	*1 1/4	31.75	1.09	27.7	1 11/16	42.9	1.75	44.50	2.62	66.55	1.62	41.2
764L _ 1 1/2	*1 1/2	38.10	1.34	34.0	2	50.8	2.00	50.80	3.07	77.98	1.97	50.0
764L _ 2	*2	50.80	1.81	45.97	2 3/4	69.9	2.75	69.85	4.22	107.19	2.66	67.6

\* Including low friction paste (see page 98)

"D" - Dimension is minimum opening. Dimensions are for reference only and subject to change without notice.

# 764 LR REDUCING TEE

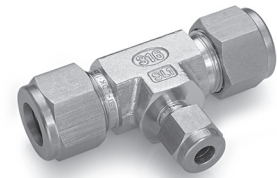
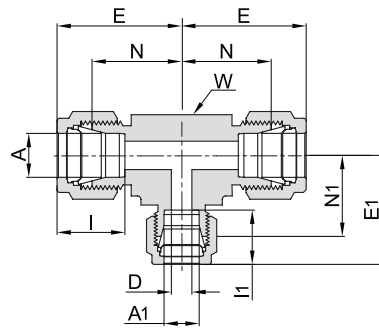
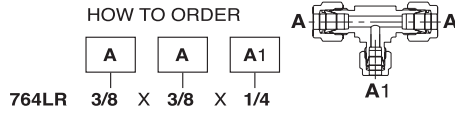

## ALL TUBE (METRIC)

Ordering Information	A Tube O.D.		A1 Tube O.D.		E		E1		I		I1		D		W Wrench Flat		N		N1	
	mm	mm	mm	mm	mm	mm	mm	mm	mm	mm	mm	mm	mm	mm	mm	mm	mm	mm	mm	
764LR_8MMX8MMX6MM	8	6	29.9	29.8	16.2	15.3	4.8	5/8	15.9	22.4	22.4									
764LR_10MMX10MMX6MM	10	6	31.5	31.3	17.2	15.3	4.8	11/16	17.5	23.9	23.9									
764LR_12MMX12MMX6MM	12	6	36.0	31.8	22.8	15.3	4.8	13/16	20.6	25.9	24.4									
764LR_12MMX12MMX10MM	12	10	36.0	33.5	22.8	17.2	7.9	13/16	20.6	25.9	25.9									
764LR_14MMX14MMX10MM	14	10	38.8	36.3	24.4	17.2	7.9	15/16	23.8	28.7	28.7									
764LR_18MMX18MMX12MM	18	12	39.8	39.8	24.4	22.8	9.5	1 1/16	27.0	29.7	29.7									
764LR_50MMX50MMX38MM	50*	38*	106.0	96.2	65.0	49.4	33.7	2 3/4	69.9	68.9	68.6									

## ALL TUBE (INCH)

Ordering Information	A Tube O.D.		A1 Tube O.D.		E		E1		I		I1		D		W Wrench Flat		N		N1	
	inch	mm	inch	mm	inch	mm	inch	mm	inch	mm	inch	mm	inch	mm	inch	mm	inch	mm	inch	mm
764LR_1/4 X 1/4 X 1/8	1/4	6.35	1/8	3.17	1.06	26.9	1.03	26.2	.60	15.2	.50	12.7	.09	2.28	1/2	12.7	.77	19.6	.77	19.6
764LR_3/8 X 3/8 X 1/4	3/8	9.52	1/4	6.35	1.20	30.5	1.14	29.0	.66	16.8	.60	15.2	.19	4.82	5/8	15.9	.91	23.1	.85	21.6
764LR_1/2 X 1/2 X 1/4	1/2	12.70	1/4	6.35	1.42	36.1	1.25	31.8	.90	22.9	.60	15.2	.19	4.82	13/16	20.6	1.02	25.9	.96	24.4
764LR_1/2 X 1/2 X 3/8	1/2	12.70	3/8	9.52	1.42	36.1	1.31	33.3	.90	22.9	.66	16.8	.28	7.11	13/16	20.6	1.02	25.9	1.02	25.9
764LR_5/8 X 5/8 X 3/8	5/8	15.88	3/8	9.52	1.53	38.9	1.42	36.1	.96	24.4	.66	16.8	.28	7.11	15/16	23.8	1.13	28.7	1.13	28.7
764LR_3/4 X 3/4 X 1/4	3/4	19.05	1/4	6.35	1.57	39.9	1.46	37.1	.96	24.4	.60	15.2	.19	4.82	1 1/16	27.0	1.17	29.7	1.17	29.7
764LR_3/4 X 3/4 X 3/8	3/4	19.05	3/8	9.52	1.57	39.9	1.46	37.1	.96	24.4	.66	16.8	.28	7.11	1 1/16	27.0	1.17	29.7	1.17	29.7
764LR_3/4 X 3/4 X 1/2	3/4	19.05	1/2	12.70	1.57	39.9	1.57	39.9	.96	24.4	.90	22.9	.41	10.41	1 1/16	27.0	1.17	29.7	1.17	29.7
764LR_1 X 1 X 3/8	1	25.4	3/8	9.52	1.93	49.0	1.65	41.9	1.23	31.2	.66	16.8	.28	7.11	1 3/8	34.9	1.45	36.8	1.36	34.5
764LR_1 X 1 X 1/2	1	25.4	1/2	12.70	1.93	49.0	1.76	44.7	1.23	31.2	.90	22.9	.41	10.41	1 3/8	34.9	1.45	36.8	1.36	34.5
764LR_1 X 1 X 3/4	1	25.4	3/4	19.05	1.93	49.0	1.76	44.7	1.23	31.2	0.96	24.4	.62	15.75	1 3/8	34.9	1.45	36.8	1.36	34.5
764LR_1 1/4 X 1 1/4 X 1	1 1/4*	31.75	1	25.40	2.67	67.8	2.17	55.1	1.62	41.2	1.23	31.2	.88	22.35	1 11/16	42.9	1.75	44.5	1.69	42.9
764LR_1 1/2 X 1 1/2 X 1	1 1/2*	38.10	1	25.40	3.10	78.7	2.36	59.9	1.97	50.0	1.23	31.2	.88	22.35	2	50.8	2.00	50.8	1.88	47.8

\* Including low friction paste (see page 101)

"D" - Dimension is minimum opening. Dimensions are for reference only and subject to change without notice.

Cont'd next page



# 764 LR REDUCING TEE (Cont'd)

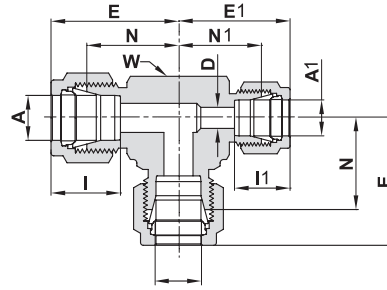
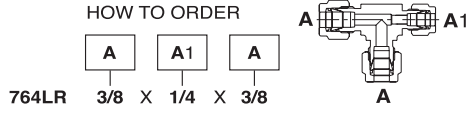

## ALL TUBE (INCH)

Ordering Information	A Tube O.D.		A1 Tube O.D.		E		E1		I		I1		D		W Wrench Flat		N		N1	
	inch	mm	inch	mm	inch	mm	inch	mm	inch	mm	inch	mm	inch	mm	inch	mm	inch	mm	inch	mm
764LR_ 1/4 X 1/8 X 1/4	1/4	6.35	1/8	3.17	1.06	26.9	1.03	26.2	.60	15.2	.50	12.7	.09	2.28	1/2	12.7	.77	19.6	.77	19.6
764LR_ 3/8 X 1/4 X 3/8	3/8	9.25	1/4	6.35	1.20	30.5	1.14	29.0	.66	16.8	.60	15.2	.19	4.82	5/8	15.9	.91	23.1	.85	21.6
764LR_ 1/2 X 1/4 X 1/2	1/2	12.7	1/4	6.35	1.42	36.1	1.31	33.3	.90	22.9	.60	15.2	.19	4.82	13/16	20.6	1.02	25.9	1.02	25.9
764LR_ 1/2 X 3/8 X 1/2	1/2	12.7	3/8	9.52	1.42	36.1	1.31	33.3	.90	22.9	.66	16.8	.28	7.11	13/16	20.6	1.02	25.9	1.02	25.9
764LR_ 3/4 X 3/8 X 3/4	3/4	19.05	3/8	9.52	1.57	39.9	1.46	37.1	.96	24.4	.66	16.8	.28	7.11	1 1/16	27.0	1.17	29.7	1.17	29.7

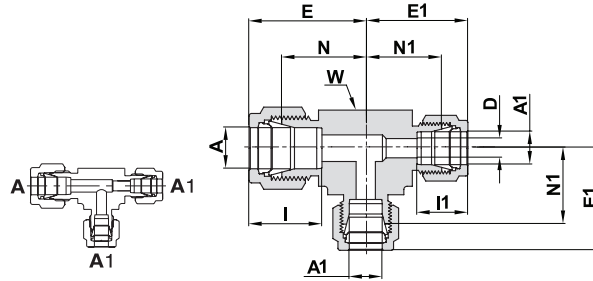
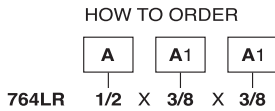

## ALL TUBE (INCH)

Ordering Information	A Tube O.D.		A1 Tube O.D.		E		E1		I		I1		D		W Wrench Flat		N		N1	
	inch	mm	inch	mm	inch	mm	inch	mm	inch	mm	inch	mm	inch	mm	inch	mm	inch	mm	inch	mm
764LR_ 1/2 X 3/8 X 3/8	1/2	12.70	3/8	9.52	1.42	36.1	1.31	33.3	.90	22.9	.66	16.8	.28	7.1	13/16	20.6	1.02	25.9	1.02	25.9
764LR_ 5/8 X 3/8 X 3/8	5/8	15.87	3/8	9.52	1.53	38.9	1.42	36.1	.96	24.4	.66	16.8	.28	7.1	15/16	23.8	1.13	28.7	1.13	28.7
764LR_ 3/4 X 3/8 X 3/8	3/4	19.05	3/8	9.52	1.57	39.9	1.46	37.1	.96	24.4	.66	16.8	.28	7.1	1 1/16	27.0	1.17	29.7	1.17	29.7

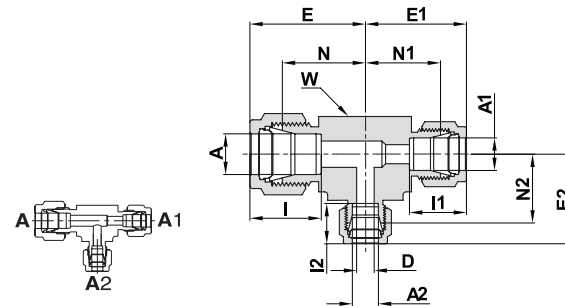
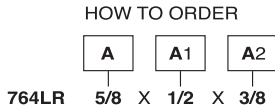

## ALL TUBE (INCH)

Ordering Information	A Tube O.D.		A1 Tube O.D.		A2 Tube O.D.		E		E1		E2		I		I1		I2		D		W Wrench Flat		N		N1&N2	
	inch	mm	inch	mm	inch	mm	inch	mm	inch	mm	inch	mm	inch	mm	inch	mm	inch	mm	inch	mm	inch	mm	inch	mm	inch	mm
764LR_ 5/8 X 1/2 X 3/8	5/8	15.87	1/2	12.70	3/8	9.52	1.53	38.9	1.53	38.9	1.42	36.1	.96	24.4	.90	22.9	.66	16.8	.28	7.11	15/16	23.8	1.13	28.7	1.13	28.7
764LR_ 3/4 X 1/2 X 3/8	3/4	19.05	1/2	12.70	3/8	9.52	1.57	39.9	1.57	39.9	1.46	37.1	.96	24.4	.90	22.9	.66	16.8	.28	7.11	1 1/16	27.0	1.17	29.7	1.17	29.7
764LR_ 1 X 3/4 X 3/8	1	25.40	3/4	19.05	3/8	9.52	1.93	49.0	1.76	44.7	1.65	41.9	1.23	31.2	.96	24.4	.66	16.8	.28	7.11	1 3/8	34.9	1.45	36.8	1.36	34.5

"D" - Dimension is minimum opening. Dimensions are for reference only and subject to change without notice.

# 765 L UNION ELBOW

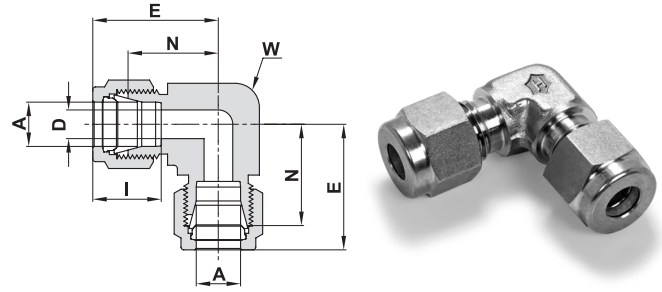

## TUBE (METRIC) TO TUBE (METRIC)

Ordering Information	A Tube O.D.		D		W Wrench Flat		N		E		I	
	mm	mm	mm	mm	inch	mm	mm	mm	mm	mm	mm	mm
765L _ 3	3		2.4		3/8	9.5		15.7		22.3		12.9
765L _ 4	4		2.4		1/2	12.7		18.8		25.4		13.7
765L _ 6	6		4.8		1/2	12.7		19.6		27.0		15.3
765L _ 8	8		6.4		9/16	14.3		21.3		28.8		16.2
765L _ 10	10		7.9		11/16	17.5		23.9		31.5		17.2
765L _ 12	12		9.5		13/16	20.6		25.9		36.0		22.8
765L _ 14	14		11.1		15/16	23.8		27.9		38.0		24.4
765L _ 15	15		11.9		15/16	23.8		27.9		38.0		24.4
765L _ 16	16		12.7		15/16	23.8		27.9		38.0		24.4
765L _ 18	18		15.1		1 1/16	27.0		29.7		39.8		24.4
765L _ 20	20		15.9		1 3/8	34.9		34.5		44.6		26.0
765L _ 22	22		18.3		1 3/8	34.9		34.5		44.6		26.0
765L _ 25	25		21.8		1 3/8	34.9		36.8		49.1		31.3
765L _ 38	38*		33.7		-	55.0		56.4		84.0		49.4
765L _ 50	50*		45.2		2 3/4	69.9		68.9		106.0		65.0

## TUBE (INCH) TO TUBE (INCH)

Ordering Information	A Tube O.D.		D		W Wrench Flat		N		E		I	
	inch	mm	inch	mm	inch	mm	inch	mm	inch	mm	inch	mm
765L _ 1/16	1/16	1.58	.05	1.27	3/8	9.5	.55	14.00	.70	17.80	.34	.86
765L _ 1/8	1/8	3.17	.09	2.28	3/8	9.5	.62	15.74	.88	22.35	.50	12.7
765L _ 3/16	3/16	4.76	.12	3.04	1/2	12.7	.74	18.80	1.00	25.40	.54	13.7
765L _ 1/4	1/4	6.35	.19	4.82	1/2	12.7	.77	19.55	1.06	26.92	.60	15.2
765L _ 5/16	5/16	7.93	.25	6.35	9/16	14.3	.84	21.33	1.13	28.70	.64	16.2
765L _ 3/8	3/8	9.52	.28	7.11	5/8	15.9	.91	23.11	1.20	30.48	.66	16.8
765L _ 1/2	1/2	12.70	.41	10.41	13/16	20.6	1.02	25.90	1.42	36.06	.90	22.9
765L _ 5/8	5/8	15.87	.50	12.70	15/16	23.8	1.10	27.94	1.50	38.10	.96	24.4
765L _ 3/4	3/4	19.05	.62	15.74	1 1/16	27.0	1.17	29.70	1.57	39.90	.96	24.4
765L _ 7/8	7/8	22.22	.72	18.29	1 3/8	34.9	1.36	34.54	1.76	44.70	1.02	25.9
765L _ 1	1	25.40	.88	22.35	1 3/8	34.9	1.45	36.83	1.93	49.00	1.23	31.2
765L _ 1 1/4	1 1/4*	31.75	1.09	27.70	1 11/16	42.9	1.75	44.50	2.62	66.55	1.62	41.2
765L _ 1 1/2	1 1/2*	38.10	1.34	34.00	2	50.8	2.00	50.80	3.07	77.98	1.97	50.0
765L _ 2	2*	50.80	1.81	45.97	2 3/4	69.9	2.75	69.85	4.22	107.19	2.66	67.6

\* Including low friction paste (see page 98)

"D" - Dimension is minimum opening. Dimensions are for reference only and subject to change without notice.

# 765 LR REDUCING UNION ELBOW

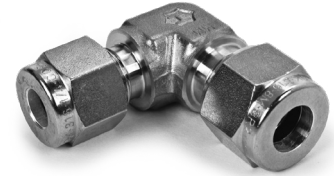
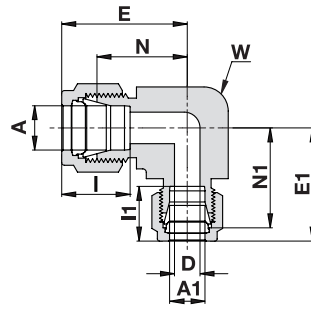

## TUBE (METRIC) TO TUBE (INCH)

Ordering Information	A Tube O.D.		A1 Tube O.D.		E		E1		I		I1		D		W Wrench Flat		N		N1	
	mm	inch	mm	inch	mm	mm	mm	mm	mm	mm	mm	mm	mm	mm	in	mm	mm	mm	mm	mm
765LR_ 6 X 1/4	6	1/4	27.0	26.9	15.3	15.2	4.8	1/2	12.7	19.6	19.6									
765LR_ 8 X 1/4	8	1/4	28.8	28.7	16.2	15.2	4.8	9/16	14.3	21.3	21.3									

## TUBE (INCH) TO TUBE (INCH)

Ordering Information	A Tube O.D.		A1 Tube O.D.		E		E1		I		I1		D		W Wrench Flat		N		N1	
	in	mm	in	mm	in	mm	in	mm	in	mm	in	mm	in	mm	in	mm	in	mm	in	mm
765LR_ 3/8 X 1/4	3/8	9.52	1/4	6.35	1.20	30.48	1.20	30.48	.66	16.8	60.	15.2	19.	4.82	5/8	15.9	.91	23.11	.91	23.11
765LR_ 5/8 X 3/8	5/8	15.87	3/8	9.52	1.50	38.10	1.39	35.31	.96	24.4	.66	16.8	.28	7.11	15/16	23.8	1.10	27.94	1.10	27.94

"D" - Dimension is minimum opening. Dimensions are for reference only and subject to change without notice.

# 766 L FEMALE CONNECTOR

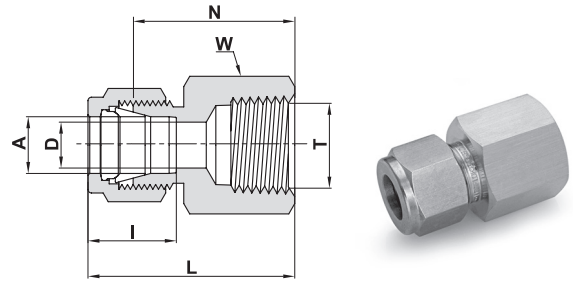

## TUBE (METRIC) TO FEMALE NPT THREAD

Ordering Information	A	T	D	W	N	L	I
	Tube O.D	(NPT)		Hex. Flat			
	mm	inch	mm	mm	mm	mm	mm
766L_ 3 X 1/8	3	1/8	2.4	14	22.1	28.7	12.9
766L_ 3 X 1/4	3	1/4	2.4	19	26.9	33.5	12.9
766L_ 4 X 1/8	4	1/8	2.4	14	23.1	29.7	13.7
766L_ 6 X 1/8	6	1/8	4.8	14	23.9	31.3	15.3
766L_ 6 X 1/4	6	1/4	4.8	19	28.4	35.8	15.3
766L_ 6 X 3/8	6	3/8	4.8	22	30.2	37.6	15.3
766L_ 6 X 1/2	6	1/2	4.8	27	35.1	42.5	15.3
766L_ 8 X 1/8	8	1/8	6.4	15	24.6	32.1	16.2
766L_ 8 X 1/4	8	1/4	6.4	19	29.5	37.0	16.2
766L_ 8 X 3/8	8	3/8	6.4	22	31.0	38.5	16.2
766L_ 8 X 1/2	8	1/2	6.4	27	35.8	43.3	16.2
766L_ 10 X 1/4	10	1/4	7.9	19	30.2	37.8	17.2
766L_ 10 X 3/8	10	3/8	7.9	22	31.8	39.4	17.2
766L_ 10 X 1/2	10	1/2	7.9	27	36.6	44.2	17.2
766L_ 12 X 1/4	12	1/4	9.5	22	30.2	40.3	22.8
766L_ 12 X 3/8	12	3/8	9.5	22	31.8	41.9	22.8
766L_ 12 X 1/2	12	1/2	9.5	27	36.6	46.7	22.8
766L_ 15 X 1/2	15	1/2	11.9	27	36.6	46.7	24.4
766L_ 16 X 1/2	16	1/2	12.7	27	36.8	46.9	24.4
766L_ 20 X 1/2	20	1/2	15.9	30	37.8	47.9	26.0
766L_ 20 X 3/4	20	3/4	15.9	35	39.6	49.7	26.0
766L_ 22 X 3/4	22	3/4	18.3	35	39.6	49.7	26.0
766L_ 22 X 1	22	1	18.3	41	47.8	57.9	26.0
766L_ 25 X 3/4	25	3/4	21.8	35	41.1	53.4	31.3
766L_ 25 X 1	25	1	21.8	41	50.0	62.3	31.3

"D" - Dimension is minimum opening. Dimensions are for reference only and subject to change without notice.

Cont'd next page

# 766 L FEMALE CONNECTOR (Cont'd)

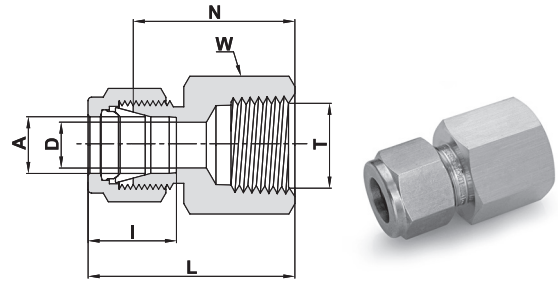

## TUBE (INCH) TO FEMALE NPT THREAD

Ordering Information	A Tube O.D		T (NPT)	D		W Hex Flat	N		L		I	
	inch	mm	inch	inch	mm	inch	inch	mm	inch	mm	inch	mm
766L_ 1/16 X 1/16	1/16	1.58	1/16	.05	1.27	7/16	.78	19.81	.93	23.62	.34	8.6
766L_ 1/16 X 1/8	1/16	1.58	1/8	.05	1.27	9/16	.81	20.57	.96	24.38	.34	8.6
766L_ 1/8 X 1/8	1/8	3.17	1/8	.09	2.28	9/16	.87	22.10	1.13	28.70	.50	12.7
766L_ 1/8 X 1/4	1/8	3.17	1/4	.09	2.28	3/4	1.06	26.92	1.32	33.52	.50	12.7
766L_ 3/16 X 1/8	3/16	4.76	1/8	.12	3.04	9/16	.91	23.11	1.17	29.71	.54	13.7
766L_ 1/4 X 1/8	1/4	6.35	1/8	.19	4.82	9/16	.94	23.87	1.23	31.24	.60	15.2
766L_ 1/4 X 1/4	1/4	6.35	1/4	.19	4.82	3/4	1.12	28.44	1.41	35.81	.60	15.2
766L_ 1/4 X 3/8	1/4	6.35	3/8	.19	4.82	7/8	1.19	30.22	1.48	37.59	.60	15.2
766L_ 1/4 X 1/2	1/4	6.35	1/2	.19	4.82	1 1/16	1.38	35.00	1.67	42.42	.60	15.2
766L_ 5/16 X 1/8	5/16	7.93	1/8	.25	6.35	9/16	.97	24.63	1.26	32.00	.64	16.2
766L_ 5/16 X 1/4	5/16	7.93	1/4	.25	6.35	3/4	1.16	29.46	1.45	36.83	.64	16.2
766L_ 3/8 X 1/8	3/8	9.52	1/8	.28	7.11	5/8	1.00	25.40	1.29	32.76	.66	16.8
766L_ 3/8 X 1/4	3/8	9.52	1/4	.28	7.11	3/4	1.19	30.22	1.48	37.59	.66	16.8
766L_ 3/8 X 3/8	3/8	9.52	3/8	.28	7.11	7/8	1.25	31.75	1.54	39.11	.66	16.8
766L_ 3/8 X 1/2	3/8	9.52	1/2	.28	7.11	1 1/16	1.44	36.57	1.73	43.94	.66	16.8
766L_ 3/8 X 3/4	3/8	9.52	3/4	.28	7.11	1 5/16	1.59	40.40	1.88	47.75	.66	16.8
766L_ 1/2 X 1/4	1/2	12.70	1/4	.41	10.41	13/16	1.19	30.22	1.59	40.38	.90	22.9
766L_ 1/2 X 3/8	1/2	12.70	3/8	.41	10.41	7/8	1.25	31.75	1.65	41.91	.90	22.9
766L_ 1/2 X 1/2	1/2	12.70	1/2	.41	10.41	1 1/16	1.44	36.57	1.84	46.73	.90	22.9
766L_ 1/2 X 3/4	1/2	12.70	3/4	.41	10.41	1 5/16	1.50	38.10	1.90	48.26	.90	22.9
766L_ 5/8 X 3/8	5/8	15.87	3/8	.50	12.70	15/16	1.25	31.75	1.65	41.91	.96	24.4
766L_ 5/8 X 1/2	5/8	15.87	1/2	.50	12.70	1 1/16	1.44	36.57	1.84	46.73	.96	24.4
766L_ 5/8 X 3/4	5/8	15.87	3/4	.50	12.70	1 5/16	1.50	38.10	1.90	48.26	.96	24.4
766L_ 3/4 X 1/2	3/4	19.05	1/2	.62	15.75	1 1/16	1.44	36.57	1.84	46.73	.96	24.4
766L_ 3/4 X 3/4	3/4	19.05	3/4	.62	15.75	1 5/16	1.50	38.10	1.90	48.26	.96	24.4
766L_ 7/8 X 3/4	7/8	22.22	3/4	.72	18.28	1 5/16	1.56	39.62	1.96	49.78	1.02	25.9
766L_ 1 X 3/4	1	25.40	3/4	.88	22.35	1 3/8	1.62	41.14	2.10	53.34	1.23	31.2
766L_ 1 X 1	1	25.40	1	.88	22.35	1 5/8	1.97	50.03	2.45	62.23	1.23	31.2
766L_ 1 1/4 X 1 1/4	1 1/4*	31.75	1 1/4	1.09	27.70	2 1/4	2.07	52.59	2.94	74.68	1.62	41.2
766L_ 1 1/2 X 1 1/2	1 1/2*	38.10	1 1/2	1.34	34.00	2 3/8	2.21	56.13	3.28	83.31	1.97	50.0
766L_ 2 X 2	2*	50.80	2	1.81	45.97	2 7/8	2.53	64.26	4.00	101.60	2.66	67.6

\* Including low friction paste (see page 98)

"D" - Dimension is minimum opening. Dimensions are for reference only and are subject to change without notice.



# 766 LR FEMALE CONNECTOR

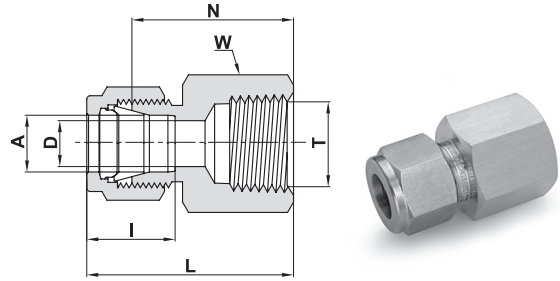

## TUBE (METRIC) TO FEMALE ISO TAPERED THREAD

Ordering Information	A	T	D	W	N	L	I
	Tube O.D.	(ISO)		Hex. Flat			
	mm	inch	mm	mm	mm	mm	mm
766LR _ 3 X 1/8	3	R-1/8	2.4	14	22.1	28.7	12.9
766LR _ 6 X 1/8	6	R-1/8	4.8	14	23.9	31.3	15.3
766LR _ 6 X 1/4	6	R-1/4	4.8	19	28.4	35.8	15.3
766LR _ 6 X 3/8	6	R-3/8	4.8	22	30.2	37.6	15.3
766LR _ 6 X 1/2	6	R-1/2	4.8	27	35.1	42.5	15.3
766LR _ 8 X 1/8	8	R-1/8	6.4	15	24.6	32.1	16.2
766LR _ 8 X 1/4	8	R-1/4	6.4	19	29.5	37.0	16.2
766LR _ 8 X 3/8	8	R-3/8	6.4	22	31.0	38.5	16.2
766LR _ 8 X 1/2	8	R-1/2	6.4	27	35.8	43.3	16.2
766LR _ 10 X 1/8	10	R-1/8	7.9	18	25.4	33.0	17.2
766LR _ 10 X 1/4	10	R-1/4	7.9	19	30.2	37.8	17.2
766LR _ 10 X 3/8	10	R-3/8	7.9	22	31.8	39.4	17.2
766LR _ 10 X 1/2	10	R-1/2	7.9	27	36.6	44.2	17.2
766LR _ 12 X 1/8	12	R-1/8	8.3	22	25.4	35.5	22.8
766LR _ 12 X 1/4	12	R-1/4	9.5	22	30.2	40.3	22.8
766LR _ 12 X 3/8	12	R-3/8	9.5	22	31.8	41.9	22.8
766LR _ 12 X 1/2	12	R-1/2	9.5	27	36.6	46.7	22.8
766LR _ 12 X 3/4	12	R-3/4	9.5	35	38.9	49.0	22.8
766LR _ 15 X 3/8	15	R-3/8	11.9	24	31.8	41.9	24.4
766LR _ 15 X 1/2	15	R-1/2	11.9	27	36.6	46.7	24.4
766LR _ 20 X 1/2	20	R-1/2	15.9	30	37.8	47.9	26.0
766LR _ 20 X 3/4	20	R-3/4	15.9	35	39.6	49.7	26.0
766LR _ 22 X 3/4	22	R-3/4	18.3	35	39.6	49.7	26.0
766LR _ 22 X 1	22	R-1	18.3	41	47.8	57.9	26.0
766LR _ 25 X 3/4	25	R-3/4	21.8	35	41.1	53.4	31.3
766LR _ 25 X 1	25	R-1	21.8	41	50.0	62.3	31.3

### Reference Specifications:

DIN -2999  
BS -21  
JIS -B0203  
ISO -7/1-BSP-T

### Designation:

Marking LR on Hex

"D" - Dimension is minimum opening. Dimensions are for reference only and subject to change without notice.

Cont'd next page

# 766 LR FEMALE CONNECTOR (Cont'd)

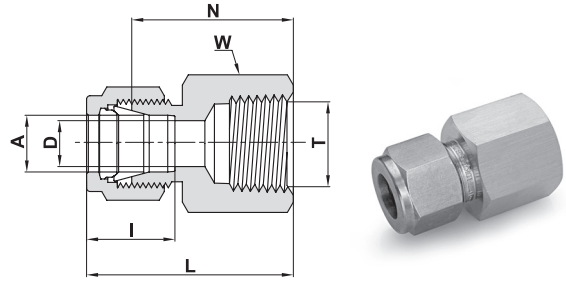

## TUBE (INCH) TO FEMALE ISO TAPERED THREAD

Ordering Information	A Tube O.D		T (ISO)	D		W Hex Flat	N		L		I	
	inch	mm	inch	inch	mm	inch	inch	mm	inch	mm	inch	mm
766LR _ 1/16 X 1/16	1/16	1.58	R-1/16	.05	1.27	7/16	.78	19.81	.93	23.62	.34	8.6
766LR _ 1/16 X 1/8	1/16	1.58	R-1/8	.05	1.27	9/16	.81	20.57	.96	24.38	.34	8.6
766LR _ 1/8 X 1/8	1/8	3.17	R-1/8	.09	2.28	9/16	.87	22.10	1.13	28.70	.50	12.7
766LR _ 1/8 X 1/4	1/8	3.17	R-1/4	.09	2.28	3/4	1.06	26.92	1.32	33.52	.50	12.7
766LR _ 3/16 X 1/8	3/16	4.76	R-1/8	.12	3.04	9/16	.91	23.11	1.17	29.71	.54	13.7
766LR _ 1/4 X 1/8	1/4	6.35	R-1/8	.19	4.82	9/16	.94	23.87	1.23	31.24	.60	15.2
766LR _ 1/4 X 1/4	1/4	6.35	R-1/4	.19	4.82	3/4	1.12	28.44	1.41	35.81	.60	15.2
766LR _ 1/4 X 3/8	1/4	6.35	R-3/8	.19	4.82	7/8	1.19	30.22	1.48	37.59	.60	15.2
766LR _ 1/4 X 1/2	1/4	6.35	R-1/2	.19	4.82	1 1/16	1.38	35.00	1.67	42.42	.60	15.2
766LR _ 5/16 X 1/4	5/16	7.93	R-1/4	.25	6.35	3/4	1.16	29.46	1.45	36.83	.64	16.2
766LR _ 3/8 X 1/8	3/8	9.52	R-1/8	.28	7.11	5/8	1.00	25.40	1.29	32.76	.66	16.8
766LR _ 3/8 X 1/4	3/8	9.52	R-1/4	.28	7.11	3/4	1.19	30.22	1.48	37.59	.66	16.8
766LR _ 3/8 X 3/8	3/8	9.52	R-3/8	.28	7.11	7/8	1.25	31.75	1.54	39.11	.66	16.8
766LR _ 3/8 X 1/2	3/8	9.52	R-1/2	.28	7.11	1 1/16	1.44	36.57	1.73	43.94	.66	16.8
766LR _ 1/2 X 1/4	1/2	12.70	R-1/4	.41	10.41	13/16	1.19	30.20	1.59	40.38	.90	22.9
766LR _ 1/2 X 3/8	1/2	12.70	R-3/8	.41	10.41	7/8	1.25	31.75	1.65	41.91	.90	22.9
766LR _ 1/2 X 1/2	1/2	12.70	R-1/2	.41	10.41	1 1/16	1.44	36.57	1.84	46.73	.90	22.9
766LR _ 5/8 X 1/2	5/8	15.87	R-1/2	.50	12.70	1 1/16	1.44	36.57	1.84	46.73	.96	24.4
766LR _ 3/4 X 1/2	3/4	19.05	R-1/2	.62	15.75	1 1/16	1.44	36.57	1.84	46.73	.96	24.4
766LR _ 3/4 X 3/4	3/4	19.05	R-3/4	.62	15.75	1 5/16	1.50	38.10	1.90	48.26	.96	24.4
766LR _ 1 X 3/4	1	25.40	R-3/4	.88	22.35	1 3/8	1.62	41.14	2.10	53.34	1.23	31.2
766LR _ 1 X 1	1	25.40	R-1	.88	22.35	1 5/8	1.97	50.03	2.45	62.23	1.23	31.2

**Reference Specifications:**

DIN -2999  
BS -21  
JIS -B0203  
ISO -7/1-BSP-T

**Designation:**  
Marking LR on Hex

"D" - Dimension is minimum opening. Dimensions are for reference only and subject to change without notice.

# 766 LG FEMALE CONNECTOR

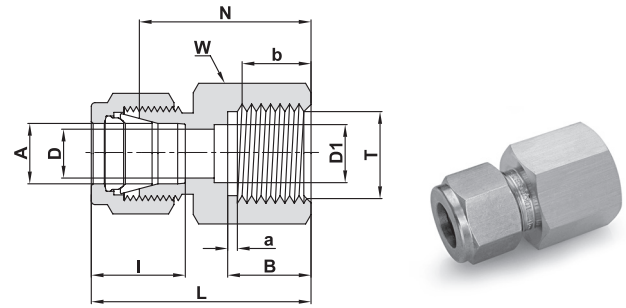

## TUBE (METRIC) TO FEMALE ISO PARALLEL THREAD

Ordering Information	A Tube O.D		T (ISO)	D	D1		W Hex. Flat	B		b Min		a Min		N		L		I
	mm	inch	inch	mm	mm	mm	mm	mm	mm	mm	mm	mm	mm	mm	mm	mm	mm	mm
766LG _ 3 X 1/4	3		G-1/4	2.4		5.5	19	13.0		9.5		1.6		28.7		35.3		12.9
766LG _ 6 X 1/8	6		G-1/8	4.0		4.0	14	10.0		7.0		1.6		25.0		32.4		15.3
766LG _ 6 X 1/4	6		G-1/4	4.8		5.5	19	13.0		9.5		1.6		30.2		37.6		15.3
766LG _ 6 X 3/8	6		G-3/8	4.8		6.5	24	14.1		10.0		1.6		30.2		37.6		15.3
766LG _ 6 X 1/2	6		G-1/2	4.8		7.0	27	19.0		15.0		1.6		36.1		43.5		15.3
766LG _ 8 X 1/4	8		G-1/4	5.5		5.5	19	13.0		9.5		1.6		31.0		38.5		16.2
766LG _ 8 X 3/8	8		G-3/8	6.4		6.4	24	14.1		10.0		1.6		28.7		36.2		16.2
766LG _ 8 X 1/2	8		G-1/2	7.0		7.0	27	19.0		15.0		1.6		33.5		41.0		16.2
766LG _ 10 X 1/4	10		G-1/4	5.5		5.5	19	13.0		9.5		1.6		31.8		39.4		17.2
766LG _ 10 X 3/8	10		G-3/8	6.5		6.5	24	14.1		10.0		1.6		31.2		38.8		17.2
766LG _ 10 X 1/2	10		G-1/2	7.0		7.0	27	19.0		15.0		1.6		34.5		42.1		17.2
766LG _ 12 X 1/4	12		G-1/4	5.5		5.5	22	13.0		9.5		1.6		31.8		41.9		22.8
766LG _ 12 X 3/8	12		G-3/8	6.5		6.5	24	14.1		10.0		1.6		34.3		44.4		22.8
766LG _ 12 X 1/2	12		G-1/2	7.0		7.0	27	19.0		15.0		1.6		38.1		48.2		22.8
766LG _ 20 X 1/2	20		G-1/2	7.0		7.0	30	19.0		15.0		1.6		44.2		54.3		26.0
766LG _ 22 X 1/2	22		G-1/2	7.0		7.0	30	19.0		15.0		1.6		44.2		54.3		26.0

## TUBE (INCH) TO FEMALE ISO PARALLEL THREAD

Ordering Information	A Tube O.D		T (ISO)	D		D1		W Hex. Flat	B		b Min		a Min		N		L		I	
	inch	mm	inch	inch	mm	inch	mm	inch	inch	mm	inch	mm	inch	mm	inch	mm	inch	mm	inch	mm
766LG _ 1/8 X 1/4	1/8	3.17	G-1/4	.09	2.3	.22	5.5	3/4	.51	13.0	.37	9.5	.06	1.6	1.13	28.7	1.39	35.3	.50	12.7
766LG _ 1/4 X 1/8	1/4	6.35	G-1/8	.16	4.0	.16	4.0	9/16	.40	10.0	.28	7.0	.06	1.6	.98	25.0	1.27	32.4	.60	15.2
766LG _ 1/4 X 1/4	1/4	6.35	G-1/4	.19	4.8	.22	5.5	3/4	.51	13.0	.37	9.5	.06	1.6	1.19	30.2	1.48	37.6	.60	15.2
766LG _ 1/4 X 3/8	1/4	6.35	G-3/8	.19	4.8	.26	6.5	15/16	.56	14.1	.39	10.0	.06	1.6	1.19	30.2	1.48	37.6	.60	15.2
766LG _ 1/4 X 1/2	1/4	6.35	G-1/2	.19	4.8	.28	7.0	1/16 1	.74	19.0	.59	15.0	.06	1.6	1.42	36.1	1.71	43.4	.60	15.2
766LG _ 5/16 X 1/4	5/16	7.93	G-1/4	.22	5.5	.22	5.5	3/4	.51	13.0	.37	9.5	.06	1.6	1.22	31.0	1.51	38.4	.64	16.2
766LG _ 5/16 X 1/2	5/16	7.93	G-1/2	.28	7.0	.28	7.0	1/16 1	.74	19.0	.59	15.0	.06	1.6	1.32	33.5	1.61	40.9	.64	16.2
766LG _ 3/8 X 1/4	3/8	9.52	G-1/4	.22	5.5	.22	5.5	3/4	.51	13.0	.37	9.5	.06	1.6	1.25	31.8	1.54	39.1	.66	16.8
766LG _ 3/8 X 3/8	3/8	9.52	G-3/8	.26	6.6	.26	6.6	15/16	.56	14.1	.39	10.0	.06	1.6	1.23	31.2	1.52	38.6	.66	16.8
766LG _ 3/8 X 1/2	3/8	9.52	G-1/2	.28	7.0	.28	7.0	1 1/16	.74	19.0	.59	15.0	.06	1.6	1.36	34.5	1.65	41.9	.66	16.8
766LG _ 1/2 X 3/8	1/2	12.7	G-3/8	.26	6.5	.26	6.5	15/16	.56	14.1	.39	10.0	.06	1.6	1.35	34.3	1.75	44.5	.90	22.9
766LG _ 1/2 X 1/2	1/2	12.7	G-1/2	.28	7.0	.28	7.0	1 1/16	.74	19.0	.59	15.0	.06	1.6	1.50	38.1	1.90	48.2	.90	22.9

### Reference Specifications:

DIN -ISO 228/1  
BS -2779  
JIS -B0202  
ISO -228/1-BSP-P

### Designation:

Marking LG on Hex

For Parallel Threads Sealing, see page 82.

"D" - Dimension is minimum opening. Dimensions are for reference only and subject to change without notice.

# 767 LT REDUCER

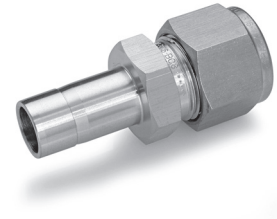
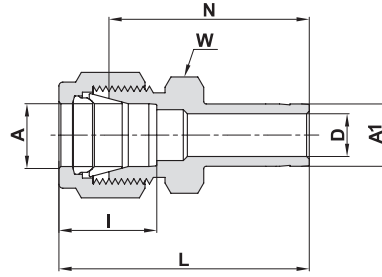

## TUBE (METRIC) TO STUB (METRIC)

Ordering Information	A	A1	D	W	N	L	I
	Tube O.D	Tube O.D.	mm	Hex. Flat	mm	mm	mm
	mm	mm	mm	mm	mm	mm	mm
767LT_2 X 3	2	3	1.7	12	26.9	33.5	12.9
767LT_3 X 4	3	4	2.2	12	28.4	35.0	12.9
767LT_3 X 6	3	6	2.4	12	29.5	36.1	12.9
767LT_3 X 10	3	10	2.4	14	31.8	38.4	12.9
767LT_4 X 6	4	6	2.4	12	30.5	37.1	13.7
767LT_6 X 3	6	3	2.1	14	29.5	36.9	15.3
767LT_6 X 8	6	8	4.8	14	32.5	39.9	15.3
767LT_6 X 10	6	10	4.8	14	33.3	40.7	15.3
767LT_6 X 12	6	12	4.8	14	38.9	46.3	15.3
767LT_6 X 18	6	18	4.8	22	42.2	49.6	15.3
767LT_8 X 6	8	6	4.0	15	32.8	40.3	16.2
767LT_8 X 10	8	10	6.4	15	34.5	42.0	16.2
767LT_8 X 12	8	12	6.4	15	40.1	47.6	16.2
767LT_10 X 6	10	6	4.0	18	34.8	42.4	17.2
767LT_10 X 8	10	8	5.6	18	35.8	43.4	17.2
767LT_10 X 12	10	12	7.9	18	42.2	49.8	17.2
767LT_10 X 15	10	15	7.9	18	43.7	51.3	17.2
767LT_10 X 18	10	18	7.9	22	43.7	51.3	17.2
767LT_12 X 6	12	6	4.0	22	34.8	44.9	22.8
767LT_12 X 8	12	8	5.6	22	35.8	45.9	22.8
767LT_12 X 10	12	10	7.1	22	36.6	46.7	22.8
767LT_12 X 16	12	16	9.5	22	43.7	53.8	22.8
767LT_12 X 18	12	18	9.5	22	43.7	53.8	22.8
767LT_12 X 20	12	20	9.5	22	46.0	56.1	22.8
767LT_12 X 22	12	22	9.5	24	46.0	56.1	22.8
767LT_12 X 25	12	25	9.5	27	52.3	62.4	22.8
767LT_16 X 12	16	12	8.8	24	42.9	53.0	24.4
767LT_18 X 12	18	12	8.8	27	44.5	54.6	24.4
767LT_18 X 16	18	16	12.7	27	46.0	56.1	24.4
767LT_18 X 20	18	20	15.1	27	47.5	57.6	24.4
767LT_18 X 22	18	22	15.1	27	47.5	57.6	24.4
767LT_18 X 25	18	25	15.1	27	52.3	62.4	24.4
767LT_20 X 16	20	16	12.7	30	47.8	57.9	26.0
767LT_20 X 18	20	18	13.9	30	47.8	57.9	26.0
767LT_20 X 22	20	22	15.9	30	49.3	59.4	26.0
767LT_20 X 25	20	25	15.9	30	54.1	64.2	26.0
767LT_22 X 18	22	18	13.9	30	47.8	57.9	26.0
767LT_22 X 20	22	20	15.1	30	49.3	59.4	26.0
767LT_22 X 25	22	25	18.3	30	54.1	64.2	26.0
767LT_25 X 18	25	18	13.9	35	50.8	63.1	31.3
767LT_25 X 20	25	20	15.1	35	52.3	64.6	31.3

"D" - Dimension is minimum opening. Dimensions are for reference only and subject to change without notice.

Cont'd next page

## 767 LT REDUCER (Cont'd)

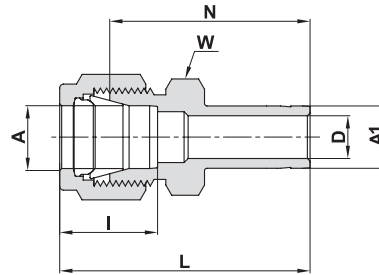

### TUBE (METRIC) TO STUB (INCH)

Ordering Information	A Tube O.D.	A1 Tube O.D.	D	W Hex. Flat	N	L	I
	mm	inch	mm	mm	mm	mm	mm
767LT_ 2 X 1/8	2	1/8	2.0	12	26.9	33.5	12.9
767LT_ 3 X 1/8	3	1/8	2.0	12	26.9	33.5	12.9
767LT_ 3 X 1/4	3	1/4	2.4	12	29.5	36.1	12.9
767LT_ 4 X 1/4	4	1/4	2.4	12	30.5	37.1	13.7
767LT_ 6 X 1/8	6	1/8	2.2	14	29.5	36.9	15.3
767LT_ 6 X 5/16	6	5/16	4.8	14	32.5	39.9	15.3
767LT_ 6 X 3/8	6	3/8	4.8	14	33.3	40.7	15.3
767LT_ 6 X 1/2	6	1/2	4.8	14	38.9	46.3	15.3
767LT_ 8 X 3/8	8	3/8	6.4	15	34.5	42.0	16.2
767LT_ 8 X 1/2	8	1/2	6.4	15	40.1	47.6	16.2
767LT_ 10 X 3/8	10	3/8	6.8	18	36.6	44.2	17.2
767LT_ 10 X 1/2	10	1/2	7.9	18	42.2	49.8	17.2
767LT_ 12 X 1/2	12	1/2	9.4	22	42.2	52.3	22.8
767LT_ 12 X 3/4	12	3/4	9.4	22	43.7	53.8	22.8
767LT_ 18 X 3/4	18	3/4	15.0	27	46.0	56.1	24.4
767LT_ 18 X 1	18	1	15.1	27	52.3	62.4	24.4
767LT_ 25 X 1	25	1	20.3	35	57.2	69.5	31.3

### HEAT EXCHANGER TEE INFORMATION

UNION TEE - 764 L

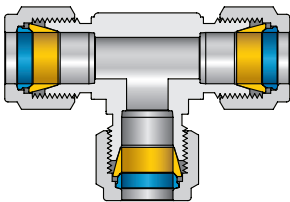

REDUCER - 767 LT

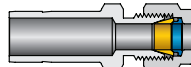

Heat exchanger tee made with  
Let-Lok tube fittings

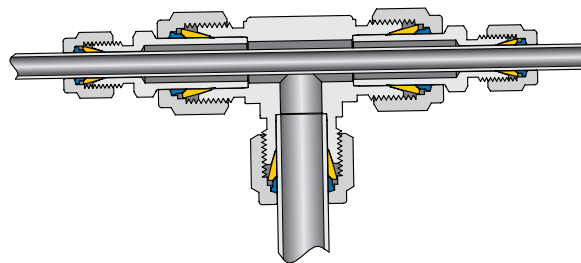

"D" - Dimension is minimum opening. Dimensions are for reference only and subject to change without notice.



**767 LT**  
**REDUCER** (Cont'd)

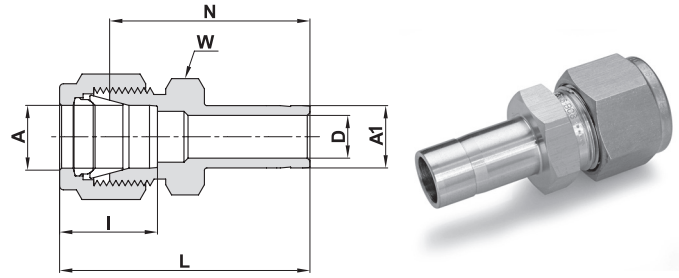

**TUBE (INCH) TO STUB (INCH)**

Ordering Information	A .Tube O.D		A1 .Tube O.D		D		W Hex Flat	N		L		I	
	inch	mm	inch	mm	inch	mm	inch	inch	mm	inch	mm	inch	mm
767LT_ 1/16 X 1/8	1/16	1.58	1/8	3.17	.05	1.27	5/16	1.00	25.40	1.15	29.21	.34	8.6
767LT_ 1/16 X 1/4	1/16	1.58	1/4	6.35	.05	1.27	5/16	1.09	27.68	1.24	31.50	.34	8.6
767LT_ 1/8 X 1/16	1/8	3.17	1/16	1.58	.03	.76	7/16	.88	22.35	1.14	28.96	.50	12.7
767LT_ 1/8 X 1/8	1/8	3.17	1/8	3.17	.08	2.03	7/16	1.06	26.92	1.32	33.52	.50	12.7
767LT_ 1/8 X 3/16	1/8	3.17	3/16	4.76	.09	2.28	7/16	1.09	27.68	1.35	34.29	.50	12.7
767LT_ 1/8 X 1/4	1/8	3.17	1/4	6.35	.09	2.28	7/16	1.16	29.46	1.42	36.06	.50	12.7
767LT_ 1/8 X 3/8	1/8	3.17	3/8	9.52	.09	2.28	7/16	1.22	30.98	1.48	37.59	.50	12.7
767LT_ 1/8 X 1/2	1/8	3.17	1/2	12.70	.09	2.28	9/16	1.48	37.59	1.74	44.20	.50	12.7
767LT_ 3/16 X 1/8	3/16	4.76	1/8	3.17	.08	2.03	7/16	1.11	28.19	1.37	34.80	.54	13.7
767LT_ 3/16 X 1/4	3/16	4.76	1/4	6.35	.12	3.04	7/16	1.20	30.48	1.46	37.08	.54	13.7
767LT_ 1/4 X 1/8	1/4	6.35	1/8	3.17	.08	2.03	1/2	1.16	29.46	1.45	36.83	.60	15.2
767LT_ 1/4 X 3/16	1/4	6.35	3/16	4.76	.12	3.04	1/2	1.19	30.22	1.48	37.59	.60	15.2
767LT_ 1/4 X 1/4	1/4	6.35	1/4	6.35	.17	4.20	1/2	1.25	31.75	1.54	39.11	.60	15.2
767LT_ 1/4 X 5/16	1/4	6.35	5/16	7.93	.19	4.82	1/2	1.28	32.51	1.57	39.87	.60	15.2
767LT_ 1/4 X 3/8	1/4	6.35	3/8	9.52	.19	4.82	1/2	1.31	33.27	1.60	40.64	.60	15.2
767LT_ 1/4 X 1/2	1/4	6.35	1/2	12.70	.19	4.82	9/16	1.53	38.86	1.82	46.22	.60	15.2
767LT_ 1/4 X 5/8	1/4	6.35	5/8	15.87	.19	4.82	11/16	1.60	40.64	1.89	48.00	.60	15.2
767LT_ 1/4 X 3/4	1/4	6.35	3/4	19.05	.19	4.82	13/16	1.59	40.39	1.88	47.75	.60	15.2
767LT_ 5/16 X 3/8	5/16	7.93	3/8	9.52	.25	6.35	9/16	1.36	34.54	1.65	41.91	.64	16.2
767LT_ 5/16 X 1/2	5/16	7.93	1/2	12.70	.25	6.35	9/16	1.58	40.13	1.87	47.49	.64	16.2
767LT_ 3/8 X 1/4	3/8	9.52	1/4	6.35	.17	4.20	5/8	1.34	34.03	1.63	41.40	.66	16.8
767LT_ 3/8 X 3/8	3/8	9.52	3/8	9.52	.27	6.85	5/8	1.41	35.81	1.70	43.18	.66	16.8
767LT_ 3/8 X 1/2	3/8	9.52	1/2	12.70	.28	7.11	5/8	1.62	41.14	1.91	48.51	.66	16.8
767LT_ 3/8 X 5/8	3/8	9.52	5/8	15.87	.28	7.11	11/16	1.69	42.92	1.98	50.29	.66	16.8
767LT_ 3/8 X 3/4	3/8	9.52	3/4	19.05	.28	7.11	13/16	1.69	42.92	1.98	50.29	.66	16.8
767LT_ 1/2 X 1/4	1/2	12.70	1/4	6.35	.17	4.20	13/16	1.37	34.80	1.77	44.96	.90	22.9
767LT_ 1/2 X 3/8	1/2	12.70	3/8	9.52	.27	6.85	13/16	1.44	36.58	1.84	46.74	.90	22.9
767LT_ 1/2 X 1/2	1/2	12.70	1/2	12.70	.37	9.40	13/16	1.66	42.16	2.06	52.32	.90	22.9
767LT_ 1/2 X 5/8	1/2	12.70	5/8	15.87	.41	10.41	13/16	1.72	43.68	2.12	53.84	.90	22.9
767LT_ 1/2 X 3/4	1/2	12.70	3/4	19.05	.41	10.41	13/16	1.72	43.68	2.12	53.84	.90	22.9
767LT_ 1/2 X 1	1/2	12.70	1	25.40	.41	10.41	1 1/16	1.97	50.03	2.37	60.19	.90	22.9
767LT_ 5/8 X 3/4	5/8	15.87	3/4	19.05	.50	12.70	15/16	1.75	44.45	2.15	54.61	.96	24.4
767LT_ 5/8 X 7/8	5/8	15.87	7/8	22.22	.50	12.70	15/16	1.81	45.97	2.21	56.13	.96	24.4
767LT_ 5/8 X 1	5/8	15.87	1	25.40	.50	12.70	1 1/16	2.00	50.80	2.40	60.96	.96	24.4
767LT_ 3/4 X 1/2	3/4	19.05	1/2	12.70	.37	9.40	1 1/16	1.75	44.45	2.15	54.61	.96	24.4
767LT_ 3/4 X 1	3/4	19.05	1	25.40	.62	15.75	1 1/16	2.06	52.32	2.46	62.48	.96	24.4
767LT_ 1 X 1 1/4	1	25.40	1 1/4*	31.75	.88	22.35	1 3/8	2.69	68.33	3.17	80.52	1.23	31.2
767LT_ 1 X 1 1/2	1	25.40	1 1/2*	38.10	.88	22.35	1 5/8	3.03	76.96	3.51	89.15	1.23	31.2
767LT_ 1 1/4 X 1 1/2	1 1/4	31.75	1 1/2*	38.10	1.09	27.7	1 3/4	3.23	82.00	4.10	104.1	1.62	41.2

**ASSEMBLY INSTRUCTIONS:** Reducer tube to stub 767 LT

\*Supplied assembled on tube stub end (A1) nut+front & back ferrule. Tighten the nut on the body 1/2 a turn with a wrench. Low friction paste (see page 98).

"D" - Dimension is minimum opening. Dimensions are for reference only and subject to change without notice.

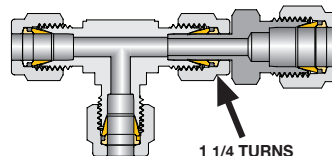

## 767 LT REDUCER (Cont'd)

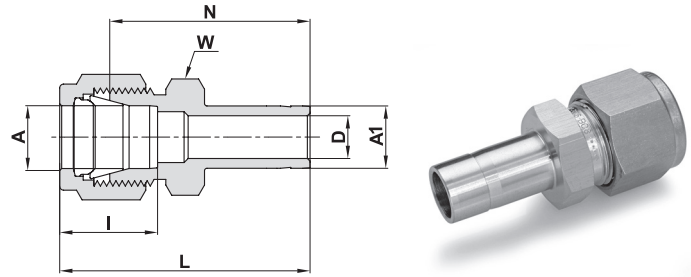

### TUBE (INCH) TO STUB (METRIC)

Ordering Information	A Tube O.D.		A1 Tube O.D.	D		W Hex. Flat	N		L		I	
	inch	mm	mm	inch	mm	inch	inch	mm	inch	mm	inch	mm
767LT _ 1/8 X 6	1/8	3.17	6	.09	2.30	7/16	1.16	29.46	1.42	36.06	.50	12.7
767LT _ 1/4 X 6	1/4	6.35	6	.16	4.00	1/2	1.25	31.75	1.54	39.11	.60	15.2
767LT _ 3/8 X 8	3/8	9.52	8	.22	5.60	5/8	1.42	36.06	1.71	43.43	.66	16.8
767LT _ 3/8 X 12	3/8	9.52	12	.28	7.11	5/8	1.62	41.15	1.91	48.51	.66	16.8

## 767 LP PORT CONNECTOR

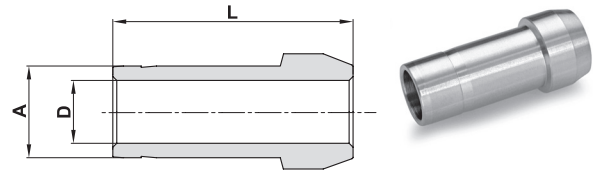

### CONNECTS TWO LET-LOK PORTS (METRIC)

Ordering Information	A Tube O.D.	D	L
	mm	mm	mm
767LP _ 3	3	2.1	22.2
767LP _ 6	6	4.0	25.0
767LP _ 8	8	5.6	25.9
767LP _ 10	10	7.1	27.1
767LP _ 12	12	8.8	36.2
767LP _ 16	16	12.7	37.4
767LP _ 18	18	13.9	37.4
767LP _ 38	38*	31.6	81.9
767LP _ 50	50*	42.8	114.0

### CONNECTS TWO LET-LOK PORTS (INCH)

Ordering Information	A Tube O.D.		D		L	
	inch	mm	inch	mm	inch	mm
767LP _ 1/16	1/16	1.58	.03	0.75	.54	13.7
767LP _ 1/8	1/8	3.17	.08	2.03	.88	22.4
767LP _ 1/4	1/4	6.35	.17	4.20	.98	24.9
767LP _ 5/16	5/16	7.93	.24	6.00	1.02	25.9
767LP _ 3/8	3/8	9.52	.27	6.85	1.03	26.2
767LP _ 1/2	1/2	12.70	.37	9.40	1.41	35.8
767LP _ 3/4	3/4	19.05	.59	15.00	1.47	37.3
767LP _ 1	1	25.40	.80	20.30	1.90	48.1
767LP _ 1 1/4	1 1/4*	31.75	1.02	26.00	2.72	69.1
767LP _ 1 1/2	1 1/2*	38.10	1.25	31.60	3.31	84.1
767LP _ 2	2*	50.80	1.72	43.67	4.56	115.8

Assembly Instructions for 767LP - See next page

# 767 LM REDUCING PORT CONNECTOR

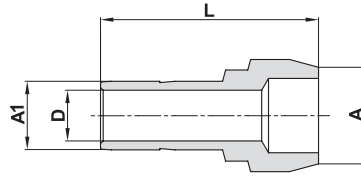

## CONNECTS TWO LET-LOK® PORTS (METRIC)

Ordering Information	A Tube O.D.		A1 Tube O.D.		D		L	
	mm	mm	mm	mm	mm	mm	mm	mm
767LM _ 6 X 3	6	3	2.1	22.9				
767LM _ 8 X 6	8	6	4.0	24.7				
767LM _ 10 X 6	10	6	4.0	25.8				
767LM _ 10 X 8	10	8	5.6	26.1				
767LM _ 12 X 6	12	6	4.0	29.1				
767LM _ 12 X 8	12	8	5.6	29.8				
767LM _ 12 X 10	12	10	7.1	30.6				
767LM _ 16 X 12	16	12	8.8	37.5				
767LM _ 38 X 25	38*	25	19.8	65.8				

## CONNECTS TWO LET-LOK® PORTS (INCH)

Ordering Information	A Tube O.D.		A1 Tube O.D.		D		L	
	inch	mm	inch	mm	inch	mm	inch	mm
767LM _ 1/8 X 1/16	1/8	3.17	1/16	1.58	.03	0.75	.68	17.3
767LM _ 1/4 X 1/16	1/4	6.35	1/16	1.58	.03	0.75	.71	18.0
767LM _ 1/4 X 1/8	1/4	6.35	1/8	3.17	.08	2.03	.89	22.6
767LM _ 3/8 X 1/8	3/8	9.52	1/8	3.17	.08	2.03	.91	23.2
767LM _ 3/8 X 1/4	3/8	9.52	1/4	6.35	.17	4.20	.98	24.9
767LM _ 1/2 X 1/4	1/2	12.70	1/4	6.35	.17	4.20	1.15	29.2
767LM _ 1/2 X 3/8	1/2	12.70	3/8	9.52	.28	7.10	1.20	30.5
767LM _ 3/4 X 1/2	3/4	19.05	1/2	12.70	.39	9.90	1.49	37.9

## Assembly Instructions for:

### Reducer Port Connector 767

1/4 turn of the nut is required for all sizes.

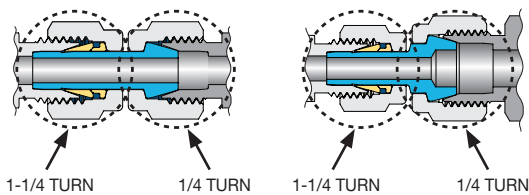

\* Supplied assembled with Nuts and Ferrules. Low friction paste (see page 98).

"D" - Dimension is minimum opening. Dimensions are for reference only and subject to change without notice.

# 768 L MALE CONNECTOR

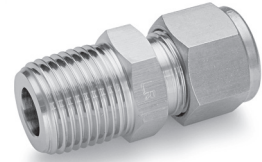
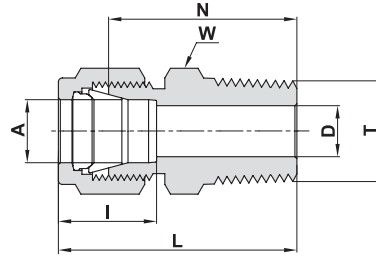

## TUBE (METRIC) MALE NPT THREAD

Ordering Information	A	T	D	W	N	L	I
	Tube O.D.	(NPT)		Hex. Flat			
	mm	inch	mm	mm	mm	mm	mm
768L_2 X 1/8	2	1/8	1.7	12	23.9	30.5	12.9
768L_3 X 1/8	3	1/8	2.4	12	23.9	30.5	12.9
768L_3 X 1/4	3	1/4	2.4	14	29.0	35.6	12.9
768L_4 X 1/8	4	1/8	2.4	12	24.6	31.2	13.7
768L_4 X 1/4	4	1/4	2.4	14	29.7	36.3	13.7
768L_6 X 1/8	6	1/8	4.8	14	25.4	32.8	15.3
768L_6 X 1/4	6	1/4	4.8	14	30.5	37.9	15.3
768L_6 X 3/8	6	3/8	4.8	18	31.0	38.4	15.3
768L_6 X 1/2	6	1/2	4.8	22	37.3	44.7	15.3
768L_8 X 1/8	8	1/8	4.8	15	26.7	34.2	16.2
768L_8 X 1/4	8	1/4	6.4	15	31.2	38.7	16.2
768L_8 X 3/8	8	3/8	6.4	18	31.8	39.3	16.2
768L_8 X 1/2	8	1/2	6.4	22	38.1	45.6	16.2
768L_10 X 1/8	10	1/8	4.8	18	28.7	36.3	17.2
768L_10 X 1/4	10	1/4	7.9	18	33.3	40.9	17.2
768L_10 X 3/8	10	3/8	7.9	18	33.3	40.9	17.2
768L_10 X 1/2	10	1/2	7.9	22	38.9	46.5	17.2
768L_10 X 3/4	10	3/4	7.9	27	40.4	48.0	17.2
768L_12 X 1/8	12	1/8	4.8	22	28.7	38.8	22.8
768L_12 X 1/4	12	1/4	7.1	22	33.3	43.4	22.8
768L_12 X 3/8	12	3/8	9.5	22	33.3	43.4	22.8
768L_12 X 1/2	12	1/2	9.5	22	38.9	49.0	22.8
768L_12 X 3/4	12	3/4	9.5	27	40.4	50.5	22.8
768L_14 X 1/4	14	1/4	7.1	24	34.0	44.1	24.4
768L_14 X 3/8	14	3/8	9.5	24	34.0	44.1	24.4
768L_14 X 1/2	14	1/2	11.1	24	38.9	49.0	24.4
768L_15 X 1/2	15	1/2	11.9	24	38.9	49.0	24.4
768L_16 X 3/8	16	3/8	9.5	24	34.0	44.1	24.4
768L_16 X 1/2	16	1/2	11.9	24	38.9	49.0	24.4
768L_16 X 3/4	16	3/4	12.7	27	40.4	50.5	24.4
768L_18 X 1/2	18	1/2	11.9	27	40.4	50.5	24.4
768L_18 X 3/4	18	3/4	15.1	27	40.4	50.5	24.4
768L_20 X 1/2	20	1/2	11.9	30	42.2	52.3	26.0
768L_20 X 3/4	20	3/4	15.9	30	42.2	52.3	26.0
768L_22 X 3/4	22	3/4	15.9	30	42.2	52.3	26.0
768L_22 X 1	22	1	18.3	35	47.0	57.1	26.0
768L_25 X 1/2	25	1/2	11.9	35	45.2	57.5	31.3
768L_25 X 3/4	25	3/4	15.9	35	45.2	57.5	31.3
768L_25 X 1	25	1	21.8	35	50.0	62.3	31.3
768L_30 X 1 1/4	30*	1 1/4	26.2	46	55.6	77.2	39.6
768L_32 X 1 1/4	32*	1 1/4	28.6	46	56.6	79.6	42
768L_38 X 1 1/2	38*	1 1/2	33.7	55	64.0	91.6	49.4
768L_50 X 2"	50*	2	45.2	3 inch	76.2	113.3	65.0

\* Supplied assembled with nuts and ferrules. For low friction paste (see page 98)

Cont'd next page

# 768 L MALE CONNECTOR (Cont'd)

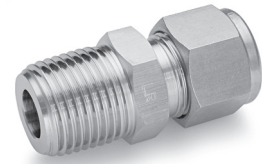
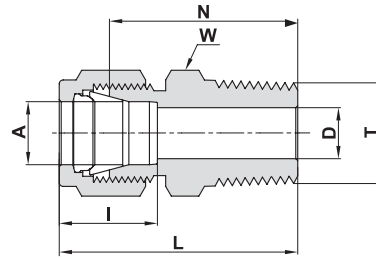

## TUBE (INCH) MALE NPT THREAD

Ordering Information	A Tube O.D.		T (NPT)	D		W Hex. Flat	N		L		I	
	inch	mm	inch	inch	mm	inch	inch	mm	inch	mm	inch	mm
768L_ 1/16 X 1/16	1/16	1.58	1/16	.05	1.27	5/16	.79	20.10	.94	23.88	.34	8.6
768L_ 1/16 X 1/8	1/16	1.58	1/8	.05	1.27	7/16	.88	22.35	1.03	26.10	.34	8.6
768L_ 1/16 X 1/4	1/16	1.58	1/4	.05	1.27	9/16	1.07	27.17	1.22	30.98	.34	8.6
768L_ 1/8 X 1/16	1/8	3.17	1/16	.09	2.28	7/16	.91	23.11	1.17	29.71	.50	12.7
768L_ 1/8 X 1/8	1/8	3.17	1/8	.09	2.28	7/16	.94	23.90	1.20	30.48	.50	12.7
768L_ 1/8 X 1/4	1/8	3.17	1/4	.09	2.28	9/16	1.14	28.95	1.40	35.56	.50	12.7
768L_ 1/8 X 3/8	1/8	3.17	3/8	.09	2.28	11/16	1.15	29.21	1.41	35.81	.50	12.7
768L_ 1/8 X 1/2	1/8	3.17	1/2	.09	2.28	7/8	1.40	35.56	1.66	42.16	.50	12.7
768L_ 3/16 X 1/8	3/16	4.76	1/8	.12	3.04	7/16	.97	24.63	1.23	31.24	.54	13.7
768L_ 3/16 X 1/4	3/16	4.76	1/4	.12	3.04	9/16	1.17	29.72	1.43	36.32	.54	13.7
768L_ 1/4 X 1/16	1/4	6.35	1/16	.12	3.04	1/2	1.00	25.40	1.29	32.76	.60	15.2
768L_ 1/4 X 1/8	1/4	6.35	1/8	.19	4.82	1/2	1.00	25.40	1.29	32.76	.60	15.2
768L_ 1/4 X 1/4	1/4	6.35	1/4	.19	4.82	9/16	1.20	30.50	1.49	37.85	.60	15.2
768L_ 1/4 X 3/8	1/4	6.35	3/8	.19	4.82	11/16	1.22	30.98	1.51	38.35	.60	15.2
768L_ 1/4 X 1/2	1/4	6.35	1/2	.19	4.82	7/8	1.47	37.34	1.76	44.70	.60	15.2
768L_ 1/4 X 3/4	1/4	6.35	3/4	.19	4.82	1 1/16	1.53	38.86	1.82	46.22	.60	15.2
768L_ 5/16 X 1/8	5/16	7.93	1/8	.19	4.82	9/16	1.05	26.67	1.34	34.03	.64	16.2
768L_ 5/16 X 1/4	5/16	7.93	1/4	.25	6.35	9/16	1.23	31.24	1.52	38.60	.64	16.2
768L_ 5/16 X 3/8	5/16	7.93	3/8	.25	6.35	11/16	1.25	31.75	1.54	39.11	.64	16.2
768L_ 3/8 X 1/8	3/8	9.52	1/8	.19	4.82	5/8	1.10	27.90	1.39	35.30	.66	16.8
768L_ 3/8 X 1/4	3/8	9.52	1/4	.28	7.11	5/8	1.28	32.51	1.57	39.87	.66	16.8
768L_ 3/8 X 3/8	3/8	9.52	3/8	.28	7.11	11/16	1.28	32.51	1.57	39.87	.66	16.8
768L_ 3/8 X 1/2	3/8	9.52	1/2	.28	7.11	7/8	1.53	38.90	1.82	46.23	.66	16.8
768L_ 3/8 X 3/4	3/8	9.52	3/4	.28	7.11	1 1/16	1.59	40.38	1.88	47.75	.66	16.8
768L_ 3/8 X 1	3/8	9.52	1	.28	7.11	1 3/8	1.85	46.99	2.14	54.35	.66	16.8
768L_ 1/2 X 1/8	1/2	12.70	1/8	.19	4.82	13/16	1.13	28.70	1.53	38.86	.90	22.9
768L_ 1/2 X 1/4	1/2	12.70	1/4	.28	7.11	13/16	1.31	33.27	1.71	43.43	.90	22.9
768L_ 1/2 X 3/8	1/2	12.70	3/8	.38	9.65	13/16	1.31	33.27	1.71	43.43	.90	22.9
768L_ 1/2 X 1/2	1/2	12.70	1/2	.41	10.41	7/8	1.53	38.90	1.93	49.02	.90	22.9
768L_ 1/2 X 3/4	1/2	12.70	3/4	.41	10.41	1 1/16	1.59	40.38	1.99	50.54	.90	22.9
768L_ 1/2 X 1	1/2	12.70	1	.41	10.41	1 3/8	1.85	47.00	2.25	57.15	.90	22.9

### Reference Specifications:

- 60° Thread angle
- Pitch measured in inches
- Truncation of root and crest is flat
- Taper angle 1° 47'

American Standard Pipe Thread (NPT).  
NPT (National Pipe Tapered) is made according to the specifications outlined in ANSI B1.20.1.

**Thermoelement** (see Page 32)

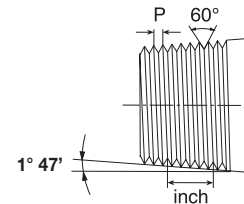

"D" - Dimension is minimum opening. Dimensions are for reference only and are subject to change without notice.

Cont'd next page



# 768 L MALE CONNECTOR (Cont'd)

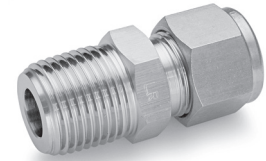
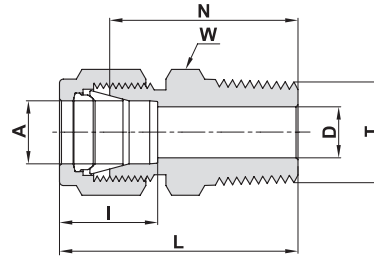

## TUBE (INCH) MALE NPT THREAD

Ordering Information	A Tube O.D.		T (NPT)	D		W Hex. Flat	N		L		I	
	inch	mm	inch	inch	mm	inch	inch	mm	inch	mm	inch	mm
768L_ 5/8 X 1/4	5/8	15.87	1/4	.28	7.11	15/16	1.34	34.03	1.74	44.19	.96	24.4
768L_ 5/8 X 3/8	5/8	15.87	3/8	.38	9.65	15/16	1.34	34.03	1.74	44.19	.96	24.4
768L_ 5/8 X 1/2	5/8	15.87	1/2	.47	11.90	15/16	1.53	38.86	1.93	49.02	.96	24.4
768L_ 5/8 X 3/4	5/8	15.87	3/4	.50	12.70	1 1/16	1.59	40.38	1.99	50.54	.96	24.4
768L_ 3/4 X 3/8	3/4	19.05	3/8	.38	9.50	1 1/16	1.38	35.05	1.78	45.21	.96	24.4
768L_ 3/4 X 1/2	3/4	19.05	1/2	.47	11.90	1 1/16	1.59	40.38	1.99	50.54	.96	24.4
768L_ 3/4 X 3/4	3/4	19.05	3/4	.62	15.75	1 1/16	1.59	40.38	1.99	50.54	.96	24.4
768L_ 3/4 X 1	3/4	19.05	1	.62	15.75	1 3/8	1.85	47.00	2.25	57.15	.96	24.4
768L_ 7/8 X 1/2	7/8	22.22	1/2	.47	11.90	1 3/16	1.59	40.38	1.99	50.54	1.02	25.9
768L_ 7/8 X 3/4	7/8	22.22	3/4	.62	15.75	1 3/16	1.59	40.38	1.99	50.54	1.02	25.9
768L_ 7/8 X 1	7/8	22.22	1	.72	18.28	1 3/8	1.85	46.99	2.25	57.15	1.02	25.9
768L_ 1 X 1/2	1	25.40	1/2	.47	11.90	1 3/8	1.78	45.21	2.26	57.40	1.23	31.2
768L_ 1 X 3/4	1	25.40	3/4	.62	15.75	1 3/8	1.78	45.21	2.26	57.40	1.23	31.2
768L_ 1 X 1	1	25.40	1	.88	22.35	1 3/8	1.97	50.03	2.45	62.23	1.23	31.2
768L_ 1 1/4 X 1	1 1/4*	31.75	1	.86	21.80	1 3/4	2.17	55.12	3.04	77.22	1.62	41.2
768L_ 1 1/4 X 1 1/4	1 1/4*	31.75	1 1/4	1.09	27.70	1 3/4	2.17	55.12	3.04	77.22	1.62	41.2
768L_ 1 1/2 X 1 1/2	1 1/2*	38.10	1 1/2	1.34	34.00	2 1/8	2.43	61.72	3.50	88.90	1.97	50.0
768L_ 2 X 2	2*	50.80	2	1.81	45.97	2 3/4	3.00	76.20	4.47	113.54	2.66	67.6

\* Including low friction paste (see page 101)

### Reference Specifications:

- 60° thread angle
- Pitch measured in inches
- Truncation of root and crest is flat
- Taper angle 1° 47'

American Standard Pipe Thread (NPT).  
NPT (National Pipe Tapered) is made according to the specifications outlined in ANSI B1.20.1.

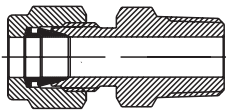
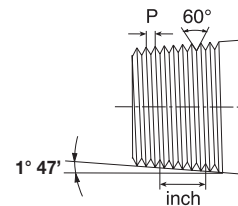

### Thermoelement

For ordering: use the catalog number of the selected fitting and add the suffix TC.  
Example: 768L SS 1/4 x 1/4 TC

## TERMOCOUPLE LET-LOK TUBE FITTINGS

Tubing O.D.	Pressure rating factor
2 mm to 12 mm, 1/8" to 1/2"	0.75 x pressure rating shown in table 1 (see page 9)
14 mm to 18 mm, 5/8" to 3/4"	0.50 x pressure rating shown in table 1 (see page 9)
20 mm to 25 mm, 7/8" to 1"	0.25 x pressure rating shown in table 1 (see page 9)

"D" - Dimension is minimum opening. Dimensions are for reference only and subject to change without notice.

# 768 LR MALE CONNECTOR

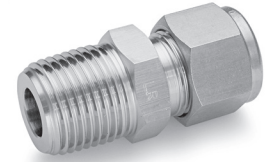
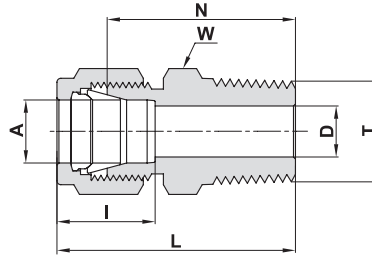

## TUBE (METRIC) ISO TAPERED THREAD

Ordering Information	A	T	D	W	N	L	I
	Tube O.D.	(ISO)		Hex. Flat			
	mm	inch	mm	mm	mm	mm	mm
768LR _ 2 X 1/8	2	R-1/8	1.7	12	23.9	30.5	12.9
768LR _ 3 X 1/8	3	R-1/8	2.4	12	23.9	30.5	12.9
768LR _ 3 X 1/4	3	R-1/4	2.4	14	29.0	35.6	12.9
768LR _ 4 X 1/8	4	R-1/8	2.4	12	24.6	31.2	13.7
768LR _ 4 X 1/4	4	R-1/4	2.4	14	29.7	36.3	13.7
768LR _ 6 X 1/8	6	R-1/8	4.8	14	25.4	32.8	15.3
768LR _ 6 X 1/4	6	R-1/4	4.8	14	30.5	37.9	15.3
768LR _ 6 X 3/8	6	R-3/8	4.8	18	31.0	38.4	15.3
768LR _ 6 X 1/2	6	R-1/2	4.8	22	37.3	44.7	15.3
768LR _ 8 X 1/8	8	R-1/8	4.8	15	26.7	34.2	16.2
768LR _ 8 X 1/4	8	R-1/4	6.4	15	31.2	38.7	16.2
768LR _ 8 X 3/8	8	R-3/8	6.4	18	31.8	39.2	16.2
768LR _ 8 X 1/2	8	R-1/2	6.4	22	38.1	45.6	16.2
768LR _ 10 X 1/8	10	R-1/8	4.8	18	28.7	36.3	17.2
768LR _ 10 X 1/4	10	R-1/4	7.9	18	33.3	40.9	17.2
768LR _ 10 X 3/8	10	R-3/8	7.9	18	33.3	40.9	17.2
768LR _ 10 X 1/2	10	R-1/2	7.9	22	38.9	46.5	17.2
768LR _ 10 X 3/4	10	R-3/4	7.9	27	40.4	48.0	17.2
768LR _ 12 X 1/4	12	R-1/4	7.1	22	33.3	43.4	22.8
768LR _ 12 X 3/8	12	R-3/8	9.5	22	33.3	43.4	22.8
768LR _ 12 X 1/2	12	R-1/2	9.5	22	38.9	49.0	22.8
768LR _ 12 X 3/4	12	R-3/4	9.5	27	40.4	50.5	22.8
768LR _ 14 X 1/4	14	R-1/4	7.1	24	34.0	44.1	24.4
768LR _ 14 X 3/8	14	R-3/8	9.5	24	34.0	44.1	24.4
768LR _ 15 X 1/2	15	R-1/2	11.9	24	38.9	49.0	24.4
768LR _ 16 X 1/4	16	R-1/4	7.1	24	34.0	44.1	24.4
768LR _ 16 X 3/8	16	R-3/8	9.5	24	34.0	44.1	24.4
768LR _ 16 X 1/2	16	R-1/2	11.9	24	38.9	49.0	24.4
768LR _ 16 X 3/4	16	R-3/4	12.7	27	40.4	50.5	24.4
768LR _ 18 X 1/2	18	R-1/2	11.9	27	40.4	50.5	24.4
768LR _ 18 X 3/4	18	R-3/4	15.1	27	40.4	50.5	24.4
768LR _ 20 X 1/2	20	R-1/2	11.9	30	42.2	52.3	26.0
768LR _ 20 X 3/4	20	R-3/4	15.9	30	42.2	52.3	26.0
768LR _ 22 X 3/4	22	R-3/4	15.9	30	42.2	52.3	26.0
768LR _ 22 X 1	22	R-1	18.3	35	47.0	57.1	26.0
768LR _ 25 X 1/2	25	R-1/2	11.9	35	45.2	57.5	31.3
768LR _ 25 X 3/4	25	R-3/4	15.9	35	45.2	57.5	31.3
768LR _ 25 X 1	25	R-1	21.8	35	45.2	57.5	31.3
768LR _ 30 X 1 1/4	30*	R-1 1/4	26.2	46	55.6	77.2	39.6

**Designation:**  
Marking LR on Hex

**Reference Specifications:** DIN - ISO 2999  
BS - 21  
JIS - B0203  
ISO - 7/1-BSP-T

**Thermoelement**  
(See Page 36)

\* Including low friction paste, (see page 98)  
"D" - Dimension is minimum opening.  
Dimensions are for reference only and  
subject to change without notice.

# 768 LR MALE CONNECTOR (Cont'd)

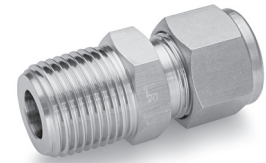
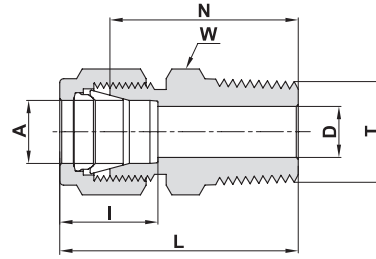

## TUBE (METRIC) ISO TAPERED THREAD

Ordering Information	A Tube O.D.	T (ISO)	D	W Hex. Flat	N	L	I
	mm	inch	mm	mm	mm	mm	mm
768LR _ 32 X 1 1/4	*32	R-1 1/4	28.6	46	56.6	79.6	42
768LR _ 38 X 1 1/2	*38	R-1 1/2	33.7	55	64.0	91.6	49.4
768LR _ 50 X 2"	*50	R-2	45.2	inch 3	76.2	113.3	65.0

## TUBE (INCH) ISO TAPERED THREAD

Ordering Information	A Tube O.D.		T (ISO)	D		W Hex. Flat	N		L		I	
	inch	mm	inch	inch	mm	inch	inch	mm	inch	mm	inch	mm
768LR _ 1/8 X 1/8	1/8	3.17	R-1/8	.09	2.28	7/16	.94	23.90	1.20	30.48	.50	12.70
768LR _ 1/8 X 1/4	1/8	3.17	R-1/4	.09	2.28	9/16	1.14	28.95	1.40	35.56	.50	12.70
768LR _ 1/4 X 1/8	1/4	6.35	R-1/8	.19	4.82	1/2	1.00	25.40	1.29	32.76	.60	15.20
768LR _ 1/4 X 1/4	1/4	6.35	R-1/4	.19	4.82	9/16	1.20	30.50	1.49	37.85	.60	15.20
768LR _ 1/4 X 3/8	1/4	6.35	R-3/8	.19	4.82	11/16	1.22	30.98	1.51	38.35	.60	15.20
768LR _ 1/4 X 1/2	1/4	6.35	R-1/2	.19	4.82	7/8	1.47	37.34	1.76	44.70	.60	15.20
768LR _ 5/16 X 1/8	5/16	7.93	R-1/8	.19	4.82	9/16	1.05	26.67	1.34	34.03	.64	16.20
768LR _ 5/16 X 1/4	5/16	7.93	R-1/4	.25	6.35	9/16	1.23	31.24	1.52	38.60	.64	16.20
768LR _ 3/8 X 1/8	3/8	9.52	R-1/8	.19	4.82	5/8	1.10	27.90	1.39	35.30	.66	16.80
768LR _ 3/8 X 1/4	3/8	9.52	R-1/4	.28	7.11	5/8	1.28	32.51	1.57	39.87	.66	16.80
768LR _ 3/8 X 3/8	3/8	9.52	R-3/8	.28	7.11	11/16	1.28	32.51	1.57	39.87	.66	16.80
768LR _ 3/8 X 1/2	3/8	9.52	R-1/2	.28	7.11	7/8	1.53	38.90	1.82	46.23	.66	16.80
768LR _ 3/8 X 3/4	3/8	9.52	R-3/4	.28	7.11	1 1/16	1.59	40.38	1.88	47.75	.66	16.80
768LR _ 1/2 X 1/4	1/2	12.70	R-1/4	.28	7.11	13/16	1.31	33.27	1.71	43.43	.90	22.90
768LR _ 1/2 X 3/8	1/2	12.70	R-3/8	.38	9.65	13/16	1.31	33.27	1.71	43.43	.90	22.90
768LR _ 1/2 X 1/2	1/2	12.70	R-1/2	.41	10.41	7/8	1.53	38.90	1.93	49.02	.90	22.90
768LR _ 1/2 X 3/4	1/2	12.70	R-3/4	.41	10.41	1 1/16	1.59	40.38	1.99	50.54	.90	22.90
768LR _ 5/8 X 1/2	5/8	15.87	R-1/2	.47	11.90	15/16	1.53	38.86	1.93	49.02	.96	24.40
768LR _ 3/4 X 3/4	3/4	19.05	R-3/4	.62	15.74	1 1/16	1.59	40.38	1.99	50.54	.96	24.40
768LR _ 3/4 X 1	3/4	19.05	R-1	.62	15.74	1 3/8	1.85	47.00	2.25	57.15	.96	24.40
768LR _ 1 X 3/4	1	25.40	R-3/4	.63	15.90	1 3/8	1.78	45.21	2.26	57.40	1.23	31.20
768LR _ 1 X 1	1	25.40	R-1	.88	22.35	1 3/8	1.97	50.03	2.45	62.23	1.23	31.20
768LR _ 1 1/4 X 1 1/4	*1 1/4	31.75	R-1 1/4	1.09	27.70	1 3/4	2.17	55.12	3.04	77.22	1.62	41.20

\* Including low friction paste, (see page 98)

### Reference Specifications:

DIN - ISO 2999  
BS - 21  
JIS - B0203  
ISO - 7/1-BSP-T

### Designation:

Marking LR on Hex

### Thermoelement (see Page 32)

55° Thread angle  
Truncation of root and crest is round  
Taper angle 1°47'

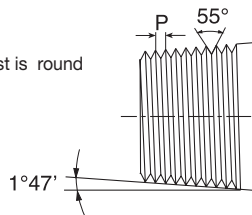

"D" - Dimension is minimum opening. Dimensions are for reference only and are subject to change without notice.

## 768 LG MALE CONNECTOR

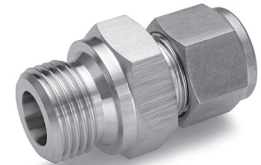
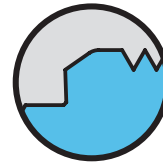
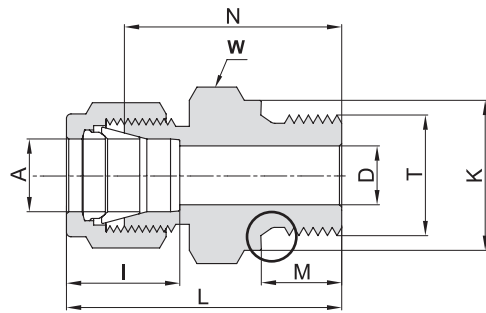

### TUBE (METRIC) ISO PARALLEL THREAD

Ordering Information	A	T	D	K	W	N	M	L	I
	Tube O.D.	(P-ISO)	mm	mm	Hex. Flat	mm	mm	mm	mm
768LG _ 2 X 1/8	2	G-1/8	1.7	13.8	14	23.4	7.1	30.0	12.9
768LG _ 3 X 1/8	3	G-1/8	2.4	13.8	14	23.4	7.1	30.0	12.9
768LG _ 3 X 1/4	3	G-1/4	2.4	18.0	19	28.7	11.2	35.3	12.9
768LG _ 4 X 1/8	4	G-1/8	2.4	13.8	14	24.1	7.1	30.7	13.7
768LG _ 6 X 1/8	6	G-1/8	4.0	13.8	14	24.9	7.1	32.3	15.3
768LG _ 6 X 1/4	6	G-1/4	4.8	18.0	19	30.2	11.2	37.6	15.3
768LG _ 6 X 3/8	6	G-3/8	4.8	21.8	22	31.5	11.2	38.9	15.3
768LG _ 6 X 1/2	6	G-1/2	4.8	26.0	27	37.3	14.2	44.7	15.3
768LG _ 8 X 1/8	8	G-1/8	4.0	13.8	15	25.7	7.1	33.2	16.2
768LG _ 8 X 1/4	8	G-1/4	6.4	18.0	19	31.0	11.2	38.5	16.2
768LG _ 8 X 3/8	8	G-3/8	6.4	21.8	22	32.3	11.2	39.8	16.2
768LG _ 8 X 1/2	8	G-1/2	6.4	26.0	27	38.1	14.2	45.6	16.2
768LG _ 10 X 1/4	10	G-1/4	5.9	18.0	19	31.8	11.2	39.4	17.2
768LG _ 10 X 3/8	10	G-3/8	7.9	21.8	22	33.0	11.2	40.6	17.2
768LG _ 10 X 1/2	10	G-1/2	7.9	26.0	27	38.9	14.2	46.5	17.2
768LG _ 12 X 1/4	12	G-1/4	5.9	18.0	22	32.5	11.2	42.6	22.8
768LG _ 12 X 3/8	12	G-3/8	7.9	21.8	22	33.0	11.2	43.1	22.8
768LG _ 12 X 1/2	12	G-1/2	9.5	26.0	27	37.4	14.2	47.5	22.8
768LG _ 12 X 3/4	12	G-3/4	9.5	32.0	35	42.7	15.7	52.8	22.8
768LG _ 14 X 3/8	14	G-3/8	7.9	21.8	24	33.8	11.2	43.9	24.4
768LG _ 14 X 1/2	14	G-1/2	11.1	26.0	27	38.9	14.2	49.0	24.4
768LG _ 15 X 3/8	15	G-3/8	7.9	21.8	24	33.8	11.2	43.9	24.4
768LG _ 15 X 1/2	15	G-1/2	11.9	26.0	27	37.4	14.2	47.5	24.4
768LG _ 15 X 3/4	15	G-3/4	11.9	32.0	35	42.1	15.7	52.8	24.4
768LG _ 16 X 3/8	16	G-3/8	7.9	21.8	24	33.8	11.2	43.9	24.4
768LG _ 16 X 1/2	16	G-1/2	11.9	26.0	27	38.9	14.2	49.0	24.4
768LG _ 16 X 3/4	16	G-3/4	12.7	32.0	35	42.1	15.7	52.8	24.4
768LG _ 18 X 1/2	18	G-1/2	11.9	26.0	27	38.9	14.2	49.0	24.4
768LG _ 18 X 3/4	18	G-3/4	15.1	32.0	35	42.7	15.7	52.8	24.4
768LG _ 20 X 1/2	20	G-1/2	11.9	26.0	30	40.4	14.2	50.5	26.0
768LG _ 20 X 3/4	20	G-3/4	15.9	32.0	35	42.7	15.7	52.8	26.0
768LG _ 22 X 3/4	22	G-3/4	15.9	32.0	35	42.7	15.7	52.8	26.0
768LG _ 22 X 1	22	G-1	18.3	39.0	41	45.2	18.3	55.3	26.0
768LG _ 25 X 3/4	25	G-3/4	15.9	32.0	35	45.2	15.7	57.5	31.3
768LG _ 25 X 1	25	G-1	19.8	39.0	41	47.8	18.3	60.1	31.3
768LG _ 30 X 1 1/4	30*	G-1 1/4	25	49	50	55.6	19.8	76.7	39.6
768LG _ 32 X 1 1/4	32*	G-1 1/4	25	49	50	56.2	19.8	79.2	42
768LG _ 38 X 1 1/2	38*	G-1 1/2	31.8	54.7	55	63.2	22.1	90.9	49.4

For parallel threads sealing (see page 82)

# 768 LG MALE CONNECTOR

(Cont'd)

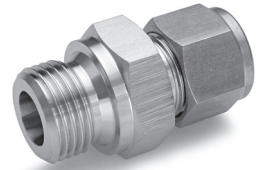
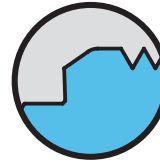
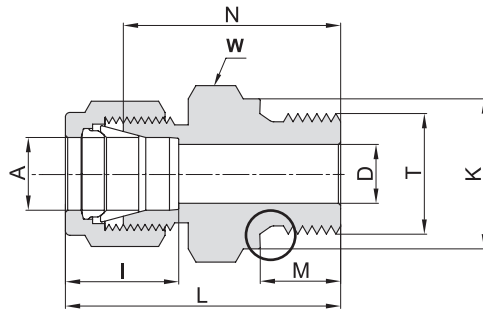

## TUBE (INCH) TO ISO PARALLEL THREAD

Ordering Information	A Tube O.D.		T (P-ISO)	D		K		W Hex. Flat	N		M		L		I	
	inch	mm		inch	mm	inch	mm		inch	mm	inch	mm	inch	mm	inch	mm
768LG _ 1/8 X 1/8	1/8	3.17	G-1/8	0.09	2.30	0.54	13.80	9/16	0.92	23.40	0.28	7.10	1.18	30.00	0.50	12.7
768LG _ 1/8 X 1/4	1/8	3.17	G-1/4	0.09	2.30	0.71	18.00	3/4	1.13	28.70	0.44	11.20	1.39	35.30	0.50	12.7
768LG _ 1/8 X 3/8	1/8	3.17	G-3/8	0.09	2.30	0.86	21.80	7/8	1.17	29.72	0.44	11.20	1.43	36.32	0.50	12.7
768LG _ 1/8 X 1/2	1/8	3.17	G-1/2	0.09	2.30	1.02	26.00	1 1/16	1.40	35.70	0.56	14.20	1.66	42.16	0.50	12.7
768LG _ 3/16 X 1/8	3/16	4.76	G-1/8	0.12	3.10	0.54	13.80	9/16	0.95	24.10	0.28	7.10	1.21	30.70	0.54	13.7
768LG _ 1/4 X 1/8	1/4	6.35	G-1/8	0.16	4.10	0.54	13.80	9/16	0.98	24.90	0.28	7.10	1.27	32.26	0.60	15.2
768LG _ 1/4 X 1/4	1/4	6.35	G-1/4	0.19	4.80	0.71	18.00	3/4	1.19	30.20	0.44	11.20	1.48	37.60	0.60	15.2
768LG _ 1/4 X 3/8	1/4	6.35	G-3/8	0.19	4.80	0.86	21.80	7/8	1.24	31.50	0.44	11.20	1.50	38.10	0.60	15.2
768LG _ 1/4 X 1/2	1/4	6.35	G-1/2	0.19	4.80	1.02	26.00	1 1/16	1.47	37.30	0.56	14.20	1.76	44.70	0.60	15.2
768LG _ 5/16 X 1/4	5/16	7.93	G-1/4	0.23	5.80	0.71	18.00	3/4	1.22	31.00	0.44	11.20	1.51	38.36	0.64	16.2
768LG _ 5/16 X 3/8	5/16	7.93	G-3/8	0.25	6.40	0.86	21.80	7/8	1.27	32.30	0.44	11.20	1.56	39.66	0.64	16.2
768LG _ 3/8 X 1/8	3/8	9.52	G-1/8	0.16	4.00	1.26	32.0	5/8	1.05	26.7	0.28	7.10	1.34	34.03	0.66	16.8
768LG _ 3/8 X 1/4	3/8	9.52	G-1/4	0.23	5.80	0.71	18.00	3/4	1.25	31.75	0.44	11.20	1.54	39.11	0.66	16.8
768LG _ 3/8 X 3/8	3/8	9.52	G-3/8	0.28	7.10	0.86	21.80	7/8	1.30	33.00	0.44	11.20	1.59	40.40	0.66	16.8
768LG _ 3/8 X 1/2	3/8	9.52	G-1/2	0.28	7.10	1.02	26.00	1 1/16	1.53	38.86	0.56	14.20	1.82	46.22	0.66	16.8
768LG _ 1/2 X 1/4	1/2	12.70	G-1/4	0.23	5.80	0.71	18.00	13/16	1.28	32.50	0.44	11.20	1.68	42.67	0.90	22.9
768LG _ 1/2 X 3/8	1/2	12.70	G-3/8	0.31	7.90	0.86	21.80	7/8	1.30	33.00	0.44	11.20	1.70	43.18	0.90	22.9
768LG _ 1/2 X 1/2	1/2	12.70	G-1/2	0.41	10.40	1.02	26.00	1 1/16	1.47	37.40	0.56	14.20	1.87	47.56	0.90	22.9
768LG _ 1/2 X 3/4	1/2	12.70	G-3/4	0.41	10.40	1.26	32.00	1 5/16	1.68	42.70	0.62	15.70	2.08	52.86	0.90	22.9
768LG _ 5/8 X 3/8	5/8	15.87	G-3/8	0.31	7.90	0.86	21.80	24mm	1.33	33.80	0.44	11.20	1.73	43.96	0.96	24.4
768LG _ 5/8 X 1/2	5/8	15.87	G-1/2	0.47	11.90	1.02	26.00	1 1/16	1.53	38.90	0.56	14.20	1.93	49.10	0.96	24.4
768LG _ 3/4 X 1/2	3/4	19.05	G-1/2	0.47	11.90	1.02	26.00	1 1/16	1.53	38.86	0.56	14.20	1.93	49.00	0.96	24.4
768LG _ 3/4 X 3/4	3/4	19.05	G-3/4	0.62	15.80	1.26	32.00	1 5/16	1.68	42.70	0.62	15.70	2.08	52.83	0.96	24.4
768LG _ 1 X 1/2	1	25.40	G-1/2	0.47	11.90	1.02	26.00	1 3/8	1.72	43.70	0.56	14.20	2.20	55.80	1.23	31.2
768LG _ 1 X 3/4	1	25.40	G-3/4	0.62	15.90	1.26	32.00	1 3/8	1.78	45.20	0.62	15.70	2.26	57.40	1.23	31.2
768LG _ 1 X 1	1	25.40	G-1	0.78	19.80	1.54	39.00	1 5/8	1.88	47.80	0.72	18.30	2.36	59.94	1.23	31.2

### Designation:

Marking LG on Hex.

### Reference Specifications:

- DIN - ISO 228/1
- BS - 2779
- JIS - B0202
- ISO - 228/1-BSP-P
- 55° thread angle
- Pitch measured in inches
- Truncation of root and crest is round
- Diameter measured in inches

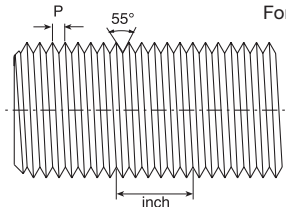

For parallel threads sealing (see page 82)



# 768 LOK MALE CONNECTOR

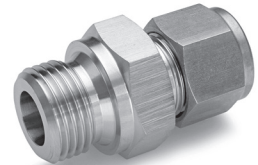
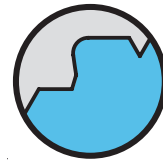
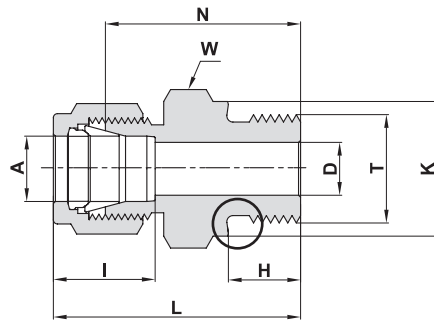

## TUBE (METRIC) ISO PARALLEL THREAD

Ordering Information	A	T	D	K	W	N	H	L	I
	Tube O.D.	(P-ISO)			Hex. Flat				
	mm	inch	mm	mm	mm	mm	mm	mm	mm
768LOK _ 3 X 1/8	3	G-1/8A	2.4	13.8	14	26.7	7.1	33.3	12.9
768LOK _ 3 X 1/4	3	G-1/4A	2.4	18.0	19	28.7	11.2	35.3	12.9
768LOK _ 4 X 1/8	4	G-1/8A	2.4	13.8	14	24.1	7.1	30.7	13.7
768LOK _ 6 X 1/8	6	G-1/8A	4.0	13.8	14	24.9	7.1	32.3	15.3
768LOK _ 6 X 1/4	6	G-1/4A	4.8	18.0	19	30.2	11.2	37.6	15.3
768LOK _ 6 X 3/8	6	G-3/8A	4.8	21.8	22	31.5	11.2	38.9	15.3
768LOK _ 6 X 1/2	6	G-1/2A	4.8	26.0	27	37.3	14.2	44.7	15.3
768LOK _ 8 X 1/8	8	G-1/8A	4.0	13.8	15	25.7	7.1	33.2	16.2
768LOK _ 8 X 1/4	8	G-1/4A	6.4	18.0	19	31.0	11.2	38.5	16.2
768LOK _ 8 X 3/8	8	G-3/8A	6.4	21.8	22	32.3	11.2	39.8	16.2
768LOK _ 8 X 1/2	8	G-1/2A	6.4	26.0	27	38.1	14.2	45.6	16.2
768LOK _ 10 X 1/4	10	G-1/4A	6.4	18.0	19	31.8	11.2	39.4	17.2
768LOK _ 10 X 3/8	10	G-3/8A	7.9	21.8	22	33.0	11.2	40.6	17.2
768LOK _ 10 X 1/2	10	G-1/2A	7.9	26.0	27	38.9	14.2	46.5	17.2
768LOK _ 12 X 1/4	12	G-1/4A	5.9	18.0	22	32.5	11.2	42.6	22.8
768LOK _ 12 X 3/8	12	G-3/8A	7.9	21.8	22	33.0	11.2	43.1	22.8
768LOK _ 12 X 1/2	12	G-1/2A	9.5	26.0	27	38.9	14.2	49.0	22.8
768LOK _ 12 X 3/4	12	G-3/4A	9.5	32.0	35	42.7	15.7	52.8	22.8
768LOK _ 15 X 1/2	15	G-1/2A	11.9	26.0	27	38.9	14.2	49.0	24.4
768LOK _ 16 X 3/8	16	G-3/8A	7.9	21.8	24	33.8	11.2	43.9	22.4
768LOK _ 16 X 1/2	16	G-1/2A	11.9	26.0	27	38.9	14.2	49.0	22.4
768LOK _ 18 X 1/2	18	G-1/2A	11.9	26.0	27	38.9	14.2	49.0	22.4
768LOK _ 18 X 3/4	18	G-3/4A	15.1	32.0	35	42.2	15.7	52.3	22.4
768LOK _ 20 X 1/2	20	G-1/2A	11.9	26.0	30	40.4	14.2	50.5	26.0
768LOK _ 20 X 3/4	20	G-3/4A	15.9	32.0	35	42.7	15.7	52.8	26.0
768LOK _ 22 X 3/4	22	G-3/4A	15.9	32.0	35	42.7	15.7	52.8	26.0
768LOK _ 22 X 1	22	G-1A	18.3	39.0	41	45.2	18.3	55.3	26.0
768LOK _ 25 X 3/4	25	G-3/4A	15.9	32.0	35	45.2	15.7	57.5	31.3
768LOK _ 25 X 1	25	G-1A	19.8	39.0	41	47.8	18.3	60.1	31.3
768LOK _ 30 X 1 1/4	30*	G-1 1/4A	26.2	49	50	55.2	19.8	76.8	39.6
768LOK _ 32 X 1 1/4	32*	G-1 1/4A	28.6	49	50	55.9	19.8	78.9	42
768LOK _ 38 X 1 1/2	38*	G-1 1/2A	31.8	54.7	55	64.9	20.6	92.1	49.4

\* Including low friction paste, (see page 101)

For parallel threads sealing (see page 82)

### Reference Specifications:

DIN - ISO 228/1  
BS - 2779  
JIS - B0202  
ISO - 228/1-BSP-P

### Designation:

Marking LOK on Hex

"D" - Dimension is minimum opening. Dimensions are for reference only and subject to change without notice.

## 768 LOK MALECONNECTOR

(Cont'd)

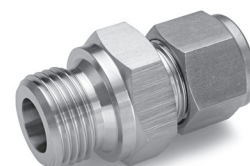
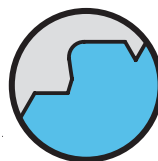
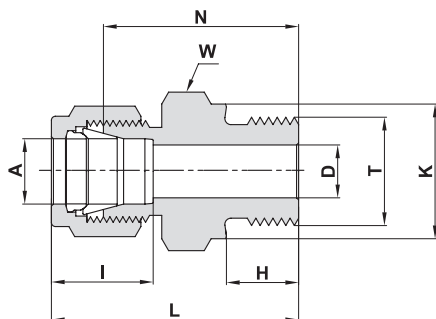

### TUBE (INCH) TO ISO PARALLEL THREAD

Ordering Information	A Tube O.D.		T Straight Thread UN	D		K		W Hex. Flat	N		H		L		I	
	inch	mm	inch	inch	mm	inch	mm	inch	inch	mm	inch	mm	inch	mm	inch	mm
768LOK _ 1/8 X 1/8	1/8	3.17	G-1/8A	0.09	2.30	0.54	13.80	9/16	0.92	23.40	0.28	7.10	1.18	30.00	0.50	12.7
768LOK _ 1/8 X 1/4	1/8	3.17	G-1/4A	0.09	2.30	0.71	18.00	3/4	1.13	28.70	0.44	11.20	1.39	35.30	0.50	12.7
768LOK _ 1/4 X 1/8	1/4	6.35	G-1/8A	0.16	4.10	0.54	13.80	9/16	0.98	24.90	0.28	7.10	1.27	32.26	0.60	15.2
768LOK _ 1/4 X 1/4	1/4	6.35	G-1/4A	0.19	4.80	0.71	18.00	3/4	1.19	30.20	0.44	11.20	1.48	37.60	0.60	15.2
768LOK _ 1/2 X 3/8	1/2	12.70	G-3/8A	0.31	7.90	0.86	21.80	7/8	1.30	33.00	0.44	11.20	1.70	43.18	0.90	22.9
768LOK _ 1/2 X 1/2	1/2	12.70	G-1/2A	0.41	10.40	1.02	26.00	1-1/16	1.53	39.86	0.56	14.20	1.93	49.02	0.90	22.9
768LOK _ 3/4 X 1/2	3/4	19.05	G-1/2A	0.47	11.90	1.02	26.00	1-1/16	3.65	41.91	0.56	14.20	2.05	52.07	0.96	24.4
768LOK _ 3/4 X 3/4	3/4	19.05	G-3/4A	0.62	15.80	1.26	32.00	1 3/8	1.68	42.70	0.62	15.70	2.08	52.83	0.96	24.4
768LOK _ 1 X 1	1	25.40	G-1A	0.78	19.80	1.54	39.00	1 5/8	1.88	47.80	0.72	18.30	2.36	59.94	1.23	31.2

For parallel threads sealing (see page 82)

**Reference Specifications:** Designation:  
DIN - ISO 228/1 Marking LOK on Hex.

BS - 2779  
JIS - B0202  
ISO - 228/1-BSP-P

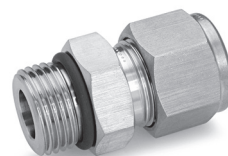
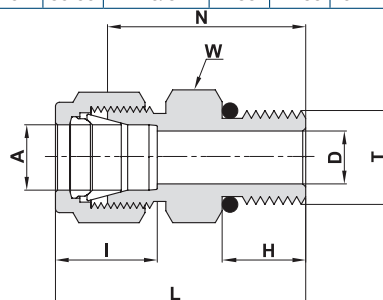

## 768 LOB MALE CONNECTOR

### SAE/MS STRAIGHT THREAD BOSS\*\*\*

Ordering Information	A Tube O.D.	T Straight Thread UN	D	W Hex. Flat	N	H	L	I	**O-Ring
	mm	inch	mm	mm	mm	mm	mm	mm	
768LOB _ 3 X 5/16-24	3	5/16-24	2.4	7/16"	23.4	7.6	30.0	12.9	-902
768LOB _ 3 X 9/16-18	3	9/16-18	2.4	18	26.7	9.9	33.3	12.9	-906
768LOB _ 6 X 1/2-20	6	1/2-20	4.8	17	27.4	9.1	34.8	15.3	-905
768LOB _ 6 X 9/16-18	6	9/16-18	4.8	18	28.2	9.9	35.6	15.3	-906
768LOB _ 6 X 7/8-14	6	7/8-14	4.8	27	33.3	12.7	40.7	15.3	-910
768LOB _ 8 X 1/2-20	8	1/2-20	6.4	17	27.4	9.1	34.9	16.2	-905
768LOB _ 8 X 9/16-18	8	9/16-18	6.4	18	29.1	9.9	36.6	16.2	-906
768LOB _ 10 X 9/16-18	10	9/16-18	7.1	18	29.7	9.9	37.3	17.2	-906
768LOB _ 10 X 3/4-16	10	3/4-16	7.9	22	31.8	11.2	39.4	17.2	-908
768LOB _ 12 X 7/16-20	12	7/16-20	5.2	22	30.5	9.1	40.6	22.8	-904
768LOB _ 12 X 9/16-18	12	9/16-18	7.1	22	29.0	9.9	39.1	22.8	-906
768LOB _ 12 X 3/4-16	12	3/4-16	9.5	22	31.8	11.2	41.9	22.8	-908
768LOB _ 16 X 9/16-18	16	9/16-18	7.1	24	21.2	9.9	31.3	24.4	-906
768LOB _ 25 X 1 1/16-12	25	1 1/16-12	16.7	35	41.2	15.0	53.5	31.3	-912

**Designation:** Marking LOB on Hex.

Per SAE J1926 and MS 16142. See page 53 for mounting dimensions.\*\*\*

Standard O-rings materials are Fluorocarbon FKM 90 Durometer. Other O-ring materials are available upon request.\*\*

"D" - Dimension is minimum opening. Dimensions are for reference only and are subject to change without notice.

# 768 LOB MALE CONNECTOR

(Cont'd)

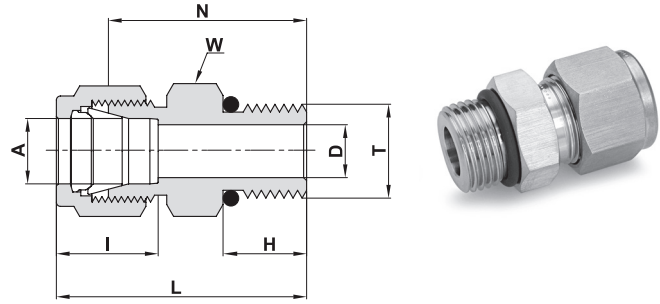

## SAE/MS STRAIGHT THREAD BOSS\*\*\*

Ordering Information	A Tube O.D.		T Straight Thread UN	D		W Hex. Flat	N		H		L		I		**O-RING
	inch	mm	inch	inch	mm	inch	inch	mm	inch	mm	inch	mm	inch	mm	
768LOB _ 1/8 X 5/16-24	1/8	3.17	5/16-24	.09	2.28	7/16	.92	23.37	.30	7.62	1.18	29.97	.50	12.7	-902
768LOB _ 1/8 X 7/16-20	1/8	3.17	7/16-20	.09	2.28	9/16	.98	24.89	.36	9.14	1.24	31.50	.50	12.7	-904
768LOB _ 1/8 X 9/16-18	1/8	3.17	9/16-18	.09	2.28	11/16	1.05	26.67	.39	9.90	1.31	33.27	.50	12.7	-906
768LOB _ 1/4 X 5/16-24	1/4	6.35	5/16-24	.09	2.28	9/16	.92	23.37	.30	7.62	1.21	30.73	.60	15.2	-902
768LOB _ 1/4 X 7/16-20	1/4	6.35	7/16-20	.19	4.82	9/16	1.05	26.67	.36	9.14	1.34	34.03	.60	15.2	-904
768LOB _ 1/4 X 9/16-18	1/4	6.35	9/16-18	.19	4.82	11/16	1.11	28.19	.39	9.90	1.40	35.56	.60	15.2	-906
768LOB _ 1/4 X 3/4 -16	1/4	6.35	3/4 -16	.19	4.82	7/8	1.19	30.20	.44	11.17	1.48	37.59	.60	15.2	-908
768LOB _ 1/4 X 7/8-14	1/4	6.35	7/8-14	.19	4.82	1	1.31	33.27	.50	12.70	1.60	40.64	.60	15.2	-910
768LOB _ 5/16 X 1/2-20	5/16	7.93	1/2-20	.25	6.40	5/8	1.08	27.43	.36	9.14	1.37	34.80	.64	16.2	-905
768LOB _ 3/8 X 7/16-20	3/8	9.52	7/16-20	.20	5.10	5/8	1.11	28.19	.36	9.14	1.40	35.56	.66	16.8	-904
768LOB _ 3/8 X 9/16-18	3/8	9.52	9/16-18	.28	7.11	11/16	1.17	29.71	.39	9.90	1.46	37.02	.66	16.8	-906
768LOB _ 3/8 X 3/4 -16	3/8	9.52	3/4 -16	.28	7.11	7/8	1.25	31.75	.44	11.17	1.54	39.11	.66	16.8	-908
768LOB _ 3/8 X 7/8-14	3/8	9.52	7/8-14	.28	7.11	1	1.37	34.80	.50	12.70	1.66	42.16	.66	16.8	-910
768LOB _ 1/2 X 9/16-18	1/2	12.70	9/16-18	.28	7.11	13/16	1.14	28.95	.39	9.90	1.54	39.11	.90	22.9	-906
768LOB _ 1/2 X 3/4 -16	1/2	12.70	3/4 -16	.41	10.41	7/8	1.25	31.75	.44	11.17	1.65	41.91	.90	22.9	-908
768LOB _ 1/2 X 7/8-14	1/2	12.70	7/8-14	.41	10.41	1	1.37	34.80	.50	12.70	1.77	44.96	.90	22.9	-910
768LOB _ 1/2 X 1 1/16-12	1/2	12.70	1 1/16-12	.41	10.41	1 1/4	1.53	38.86	.59	14.98	1.93	49.02	.90	22.9	-912
768LOB _ 5/8 X 3/4 -16	5/8	15.87	3/4 -16	.42	10.66	15/16	1.25	31.75	.44	11.17	1.65	41.91	.96	22.4	-908
768LOB _ 5/8 X 7/8 -14	5/8	15.87	7/8 -14	.50	12.70	1	1.38	35.05	.50	12.70	1.78	45.21	.96	22.4	-910
768LOB _ 3/4 X 3/4 -16	3/4	19.05	3/4 -16	.42	10.66	1 1/16	1.41	35.81	.44	11.17	1.81	46.0	.96	22.4	-908
768LOB _ 3/4 X 1 1/16 -12	3/4	19.05	1 1/16 -12	.62	15.74	1 1/4	1.53	38.86	.59	14.98	1.93	49.02	.96	22.4	-912
768LOB _ 3/4 X 1 5/16-12	3/4	19.05	1 5/16-12	.62	15.74	1 1/2	1.66	42.16	.59	14.98	2.06	52.32	1.02	25.9	-916
768LOB _ 7/8 X 1 3/16 -12	7/8	22.22	1 3/16 -12	.72	18.29	1 3/8	1.53	38.86	.59	14.98	1.93	49.02	1.02	25.9	-914
768LOB _ 1 X 1 1/16 -12	1	25.40	1 1/16 -12	.66	16.76	1 3/8	1.62	41.20	.59	14.98	2.10	53.34	1.23	31.2	-912
768LOB _ 1 X 1 5/16 -12	1	25.40	1 5/16 -12	.88	22.35	1 1/2	1.66	42.16	.59	14.98	2.14	54.35	1.23	31.2	-916
768LOB _ 1 1/4 X 1 5/8 -12	1 1/4*	31.75	1 5/8 -12	1.09	27.70	1 7/8	1.82	46.23	.59	15.10	2.69	68.33	1.62	41.2	-920
768LOB _ 1 1/2 X 1 7/8 -12	1 1/2*	38.10	1 7/8 -12	1.34	34.00	2 1/8	1.99	50.55	.59	15.10	3.06	77.72	1.97	50.0	-924
768LOB _ 2 X 2 1/2 -12	*2	50.80	2 1/2 -12	1.81	45.97	2 3/4	2.53	64.26	.59	15.10	4.00	101.60	2.66	67.6	-932

**Designation:** Marking LOB on Hex.

Per SAE J1926 and MS 16142. See page 53 for mounting dimensions.\*\*\*

Standard O-rings materials are Fluorocarbon FKM 90 Durometer. Other O-ring materials are available upon request.\*\*

Including low friction paste, see page 9\*

\*"D" - Dimension is minimum opening. Dimensions are for reference only and are subject to change without notice.

## 768 LOP MALE CONNECTOR

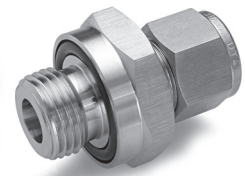
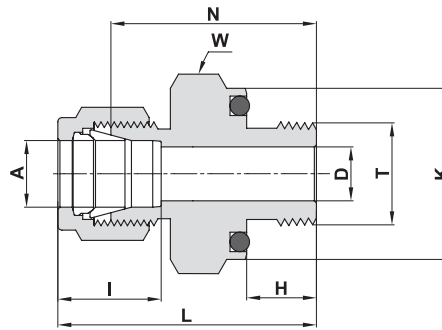

### O-SEAL NPT TAPERED THREAD

Ordering Information	A Tube O.D.		T NPT) Short)	D Hex. Flat		K		W Hex. Flat	N		H		L		I	O-RING**	
	inch	mm	inch	inch	mm	inch	mm	inch	inch	mm	inch	mm	inch	mm	inch		mm
768LOP_ 1/8 X 1/8	1/8	3.17	1/8	.09	2.28	.74	18.79	3/4	1.03	26.16	.28	7.11	1.29	32.76	.50	12.7	-111
768LOP_ 1/4 X 1/8	1/4	6.35	1/8	.19	4.82	.74	18.79	3/4	1.09	27.70	.28	7.11	1.38	35.05	.60	15.2	-111
768LOP_ 1/4 X 1/4	1/4	6.35	1/4	.19	4.82	.93	23.62	15/16	1.22	31.00	.38	9.65	1.51	38.40	.60	15.2	-113
768LOP_ 3/8 X 1/4	3/8	9.52	1/4	.28	7.11	.93	23.62	15/16	1.28	32.51	.38	9.65	1.57	39.88	.66	16.8	-113
768LOP_ 3/8 X 3/8	3/8	9.52	3/8	.28	7.11	1.12	28.45	1 1/8	1.34	34.04	.41	10.41	1.63	41.40	.66	16.8	-116
768LOP_ 3/8 X 1/2	3/8	9.52	1/2	.28	7.11	1.30	33.02	1 5/16	1.56	39.62	.53	13.46	1.85	46.99	.66	16.8	-212
768LOP_ 1/2 X 1/2	1/2	12.70	1/2	.41	10.41	1.30	33.02	1 5/16	1.56	39.62	.53	13.46	1.96	49.78	.90	22.9	-212

**Designation:** Marking LOP on Hex.

\*\* Standard O-rings materials are Fluorocarbon FKM 90 Durometer. Other O-ring materials are available upon request.

## 768 LO MALE CONNECTOR

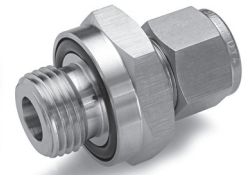
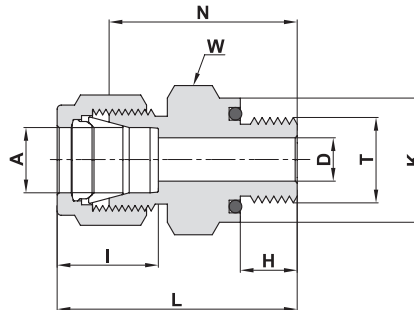

### O-SEAL MALE UN THREAD

Ordering Information	A Tube O.D.		T Straight Thread UN	D		K		W Hex. Flat	N		H		L		I	O-RING**	
	inch	mm	inch	inch	mm	inch	mm	inch	inch	mm	inch	mm	inch	mm	inch		mm
768LO_ 1/16 X 5/16-24	1/16	1.58	5/16-24	.05	1.27	.55	14.0	9/16	.90	22.86	.34	8.63	1.05	26.67	.34	8.6	-011
768LO_ 1/8 X 5/16-24	1/8	3.17	5/16-24	.09	2.28	.55	14.0	9/16	1.03	26.20	.34	8.63	1.29	32.77	.50	12.7	-011
768LO_ 3/16 X 3/8 -24	3/16	4.76	3/8 -24	.12	3.04	.62	15.75	5/8	1.09	27.70	.38	9.65	1.35	34.29	.54	12.7	-012
768LO_ 1/4 X 7/16-20	1/4	6.35	7/16-20	.19	4.82	.74	18.80	3/4	1.22	31.00	.41	10.41	1.51	38.35	.60	15.2	-111
768LO_ 5/16 X 1/2 -20	5/16	7.93	1/2 -20	.25	6.35	.86	21.84	7/8	1.31	33.30	.44	11.17	1.60	40.64	.64	16.2	-112
768LO_ 3/8 X 9/16-18	3/8	9.52	9/16-18	.28	7.11	.93	23.62	15/16	1.38	35.05	.47	11.93	1.67	40.89	.66	16.8	-113
768LO_ 1/2 X 3/4 -16	1/2	12.70	3/4 -16	.41	10.41	1.12	28.45	1 1/8	1.41	35.81	.47	11.93	1.81	45.77	.90	22.9	-116
768LO_ 3/4 X 1 1/16-12	3/4	19.05	1 1/16-12	.62	15.74	1.49	37.85	1 1/2	1.66	42.20	.56	14.22	2.06	52.32	.96	24.4	-215

**Designation:** Marking LO on Hex.

\*\* Standard O-rings materials are Fluorocarbon FKM 90 Durometer. Other O-ring materials available upon request.

"D" - Dimension is minimum opening. Dimensions are for reference only and subject to change without notice.

# 768 LN MALE PIPE WELD CONNECTOR

Cont'd next page

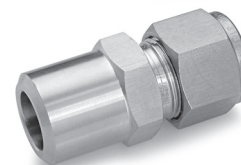
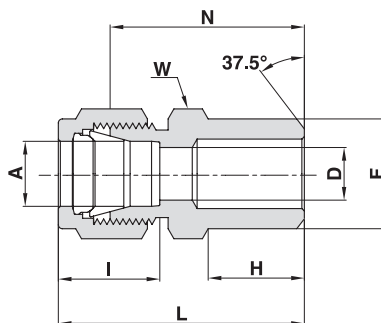

## TUBE (METRIC)

Ordering Information	A Tube O.D.		F Pipe Size		D	W Hex. Flat	N	H	L	I
	mm	inch	mm	mm	mm	mm	mm	mm	mm	mm
768LN _ 3 X 1/8	3	1/8	10.30	2.4	12	23.9	9.7	30.5	12.9	
768LN _ 4 X 1/8	4	1/8	10.30	2.4	12	24.6	9.7	31.2	13.7	
768LN _ 6 X 1/8	6	1/8	10.30	4.8	14	25.4	9.7	32.8	15.3	
768LN _ 6 X 1/4	6	1/4	13.70	4.8	14	30.5	14.2	37.9	15.3	
768LN _ 8 X 1/8	8	1/8	10.30	5.1	15	26.7	9.7	34.2	16.2	
768LN _ 8 X 1/4	8	1/4	13.70	6.4	15	31.2	14.2	38.7	16.2	
768LN _ 8 X 1/2	8	1/2	21.34	6.4	22	38.1	19.0	45.6	16.2	
768LN _ 10 X 1/4	10	1/4	13.70	7.1	18	33.3	14.2	40.9	17.2	
768LN _ 10 X 3/8	10	3/8	17.10	7.9	18	33.3	14.2	40.9	17.2	
768LN _ 10 X 1/2	10	1/2	21.34	7.9	22	38.9	19.0	46.5	17.2	
768LN _ 12 X 1/4	12	1/4	13.70	7.1	22	33.3	14.2	43.4	22.8	
768LN _ 12 X 3/8	12	3/8	17.10	9.5	22	33.3	14.2	43.4	22.8	
768LN _ 12 X 1/2	12	1/2	21.34	9.5	22	38.9	19.0	49.0	22.8	
768LN _ 12 X 3/4	12	3/4	26.67	9.5	27	40.4	19.0	50.5	22.8	
768LN _ 14 X 3/8	14	3/8	17.10	10.4	24	34.0	14.2	44.1	24.4	
768LN _ 15 X 1/2	15	1/2	21.34	11.9	24	38.9	19.0	49.0	24.4	
768LN _ 16 X 1/2	16	1/2	21.34	12.7	24	38.9	19.0	49.0	24.4	
768LN _ 18 X 1/2	18	1/2	21.34	13.5	27	40.4	19.0	50.5	24.4	
768LN _ 30 X 1 1/4	30*	1 1/4	42.2	26.2	46	55.6	23.9	77.2	39.6	
768LN _ 32 X 1 1/4	32*	1 1/4	42.2	28.6	46	56.6	23.9	79.6	42	
768LN _ 38 X 1 1/2	38*	1 1/2	48.30	33.7	55	64.0	26.2	91.2	49.4	

**Designation:** Marking LN on Hex

\* Including low friction paste (see page 98)

"D" - Dimension is minimum opening. Dimensions are for reference only and subject to change without notice.

# 768 LN MALE PIPE WELD CONNECTOR (Cont'd)

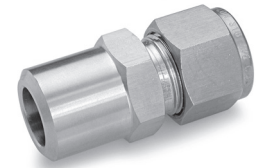
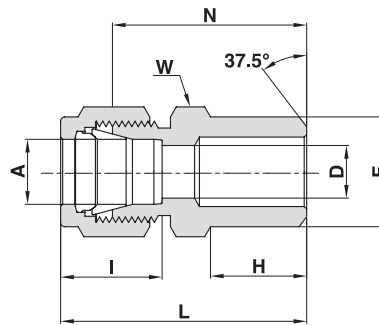

## TUBE (INCH)

Ordering Information	A Tube O.D.		F Pipe Size		D		W Hex. Flat	N		H		L		I	
	inch	mm	inch	mm	inch	mm	inch	inch	mm	inch	mm	inch	mm	inch	mm
768LN_ 1/8 X 1/8	1/8	3.17	1/8	10.30	.09	2.28	7/16	.94	23.88	.38	9.65	1.20	30.48	.50	12.7
768LN_ 3/16 X 1/8	3/16	4.76	1/8	10.30	.12	3.04	7/16	.97	24.60	.38	9.65	1.23	31.25	.54	13.7
768LN_ 1/4 X 1/8	1/4	6.35	1/8	10.30	.19	4.82	1/2	1.00	25.40	.38	9.65	1.29	32.77	.60	15.2
768LN_ 1/4 X 1/4	1/4	6.35	1/4	13.70	.19	4.82	9/16	1.20	30.48	.56	14.22	1.49	37.85	.60	15.2
768LN_ 5/16 X 1/8	5/16	7.93	1/8	10.30	.20	5.08	9/16	1.05	26.67	.38	9.65	1.34	34.04	.64	16.2
768LN_ 5/16 X 1/4	5/16	7.93	1/4	13.70	.25	6.35	9/16	1.23	31.24	.56	14.22	1.52	38.61	.64	16.2
768LN_ 3/8 X 1/4	3/8	9.52	1/4	13.70	.28	7.11	5/8	1.28	32.51	.56	14.22	1.57	39.87	.66	16.8
768LN_ 3/8 X 3/8	3/8	9.52	3/8	17.10	.28	7.11	11/16	1.28	32.51	.56	14.22	1.57	39.87	.66	16.8
768LN_ 3/8 X 1/2	3/8	9.52	1/2	21.34	.28	7.11	7/8	1.53	38.86	.75	19.05	1.82	46.22	.66	16.8
768LN_ 3/8 X 3/4	3/8	9.52	3/4	26.67	.28	7.11	1 1/16	1.59	40.38	.75	19.05	1.88	47.75	.66	16.8
768LN_ 1/2 X 3/8	1/2	12.70	3/8	17.10	.41	10.41	13/16	1.31	33.27	.56	14.22	1.71	44.43	.90	22.9
768LN_ 1/2 X 1/2	1/2	12.70	1/2	21.34	.41	10.41	7/8	1.53	38.86	.75	19.05	1.93	49.00	.90	22.9
768LN_ 1/2 X 3/4	1/2	12.70	3/4	26.67	.41	10.41	1 1/16	1.59	40.40	.75	19.05	1.99	50.55	.90	22.9
768LN_ 1/2 X 1	1/2	12.70	1	33.40	.41	10.41	1 3/8	1.87	47.50	.94	23.87	2.27	57.65	.90	22.9
768LN_ 5/8 X 1/2	5/8	15.87	1/2	21.34	.50	12.70	1 5/16	1.53	38.86	.75	19.05	1.93	49.02	.96	24.4
768LN_ 3/4 X 1/2	3/4	19.05	1/2	21.34	.53	13.46	1 1/16	1.53	38.86	.75	19.05	1.93	49.00	.96	24.4
768LN_ 3/4 X 3/4	3/4	19.05	3/4	26.67	.62	15.74	1 1/16	1.59	40.40	.75	19.05	1.99	50.55	.96	24.4
768LN_ 1 X 1	1	25.40	1	33.40	.88	22.35	1 3/8	1.97	50.03	.94	23.87	2.45	62.23	1.23	31.2
768LN_ 1 1/4 X 1 1/4	1 1/4*	31.75	1 1/4	42.16	1.09	27.70	1 3/4	2.17	55.12	.94	23.88	3.04	77.22	1.62	41.2
768LN_ 1 1/2 X 1 1/2	1 1/2*	38.10	1 1/2	48.26	1.34	34.00	2 1/8	2.43	61.72	1.03	26.16	3.50	88.90	1.97	50.0
768LN_ 2 X 2	2*	50.80	2	60.33	1.81	45.97	2 3/4	3.00	76.20	1.06	26.92	4.47	113.34	2.66	67.6

Designation: Marking LN on Hex

# 768 LW TUBE SOCKET WELD UNION

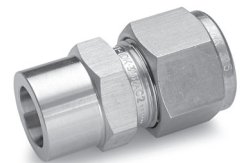
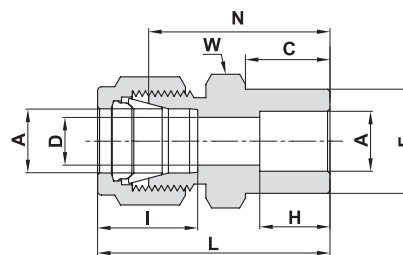

## TUBE (INCH)

Ordering Information	A Tube O.D.		C		D		W Hex. Flat	F		H		I		L		N	
	inch	mm	inch	mm	inch	mm	inch	inch	mm	inch	mm	inch	mm	inch	mm	inch	mm
768LW_ 1/8 X 1/8	1/8	3.17	.34	8.64	.09	2.28	7/16	.31	7.87	.25	6.35	.50	12.70	1.14	28.96	.88	22.35
768LW_ 1/4 X 1/4	1/4	6.35	.41	10.41	.19	4.80	1/2	.44	11.18	.31	7.90	.60	15.20	1.32	33.53	1.03	26.16
768LW_ 3/8 X 3/8	3/8	9.52	.47	11.94	.28	7.10	5/8	.62	15.75	.38	9.65	.66	16.80	1.48	37.60	1.19	30.23
768LW_ 1/2 X 1/2	1/2	12.70	.47	11.94	.41	10.40	13/16	.75	19.05	.50	12.70	.90	22.90	1.62	41.15	1.22	31.00
768LW_ 3/4 X 3/4	3/4	19.05	.47	11.94	.62	15.80	1 1/16	1.05	26.67	.56	14.20	.96	24.40	1.71	43.43	1.31	33.28
768LW_ 1 X 1	1	25.40	.56	14.22	.88	22.35	1 3/8	1.36	34.54	.75	19.05	1.23	31.20	2.07	52.58	1.59	40.40

Designation: Marking LW on Hex.

"D" - Dimension is minimum opening. Dimensions are for reference only and are subject to change without notice.

**768 LSF**  
**SANITARY FLANGE**

LET-LOK TO SANITARY CLAMP FLANGE

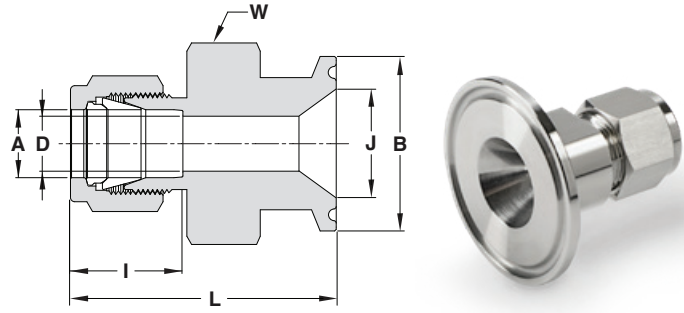

FOR HYGIENIC SEALING AND LET-LOK FERRULE CONNECTION TO METAL TUBES

Ordering Information	A Tube O.D.		Flange size	B		J		D		W	L		I	
	inch	mm		inch	inch	mm	inch	mm	inch		mm	inch	mm	inch
768LSF SS 1/4 X 1/2	1/4	6.35	1/2	0.98	24.90	0.37	9.40	0.19	4.82	1	1.57	39.90	0.60	15.2
768LSF SS 1/4 X 3/4	1/4	6.35	3/4	0.98	24.90	0.62	15.70	0.19	4.82	1	1.57	39.90	0.60	15.2
768LSF SS 1/4 X 1	1/4	6.35	1	1.98	50.30	0.87	22.10	0.19	4.82	1-3/8	1.57	39.90	0.60	15.2
768LSF SS 1/4 X 1-1/2	1/4	6.35	1-1/2	1.98	50.30	1.37	34.80	0.19	4.82	1-3/8	1.57	39.90	0.60	15.2
768LSF SS 3/8 X 1/2	3/8	9.52	1/2	0.98	24.90	0.37	9.40	0.28	7.11	1	1.63	41.40	0.66	16.8
768LSF SS 3/8 X 3/4	3/8	9.52	3/4	0.98	24.90	0.62	15.70	0.28	7.11	1	1.63	41.40	0.66	16.8
768LSF SS 3/8 X 1	3/8	9.52	1	1.98	50.30	0.87	22.10	0.28	7.11	1-3/8	1.63	41.40	0.66	16.8
768LSF SS 3/8 X 1-1/2	3/8	9.52	1-1/2	1.98	50.30	1.37	34.80	0.28	7.11	1-3/8	1.63	41.40	0.66	16.8
768LSF SS 1/2 X 1/2	1/2	12.70	1/2	0.98	24.90	0.37	9.40	0.37	9.40	1	1.74	44.20	0.90	22.9
768LSF SS 1/2 X 3/4	1/2	12.70	3/4	0.98	24.90	0.62	15.70	0.41	10.41	1	1.74	44.20	0.90	22.9
768LSF SS 1/2 X 1	1/2	12.70	1	1.98	50.30	0.87	22.10	0.41	10.41	1-3/8	1.74	44.20	0.90	22.9
768LSF SS 1/2 X 1-1/2	1/2	12.70	1-1/2	1.98	50.30	1.37	34.80	0.41	10.41	1-3/8	1.74	44.20	0.90	22.9
768LSF SS 1 X 1	1	25.40	1	1.98	50.30	0.87	22.10	0.88	22.35	1-3/8	1.92	48.80	1.23	31.2
768LSF SS 1 X 2	1	25.40	2	2.52	64.00	1.87	47.50	0.88	22.35	2-3/4	2.50	63.50	1.23	31.2

**768 LTC**  
**TRI-CLAMP FITTINGS**

LET-LOK TO TRI-CLAMP

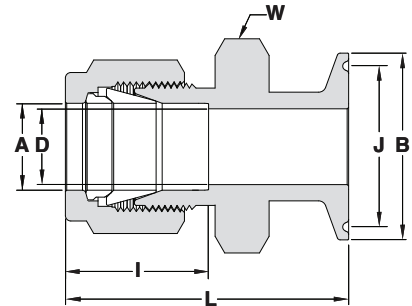

TUBE (INCH) TO TRI-CLAMP

Ordering Information	A Tube O.D.		Tri-Clamp size	B		J		D		W Hex. Flat	L		I	
	inch	mm		inch	inch	mm	inch	mm	inch		mm	inch	mm	inch
768LTC SS 1/2 X 1/2	1/2	12.7	1/2	1	25.4	0.8	20.3	0.37	9.4	1-1/16	2.1	53.3	0.9	22.9
768LTC SS 3/4 X 3/4	3/4	19.05	3/4	1	25.4	0.8	20.3	0.62	15.8	1-1/16	2.1	53.3	0.96	24.4
768LTC SS 1 X 1	1	25.4	1	1.99	50.5	1.71	43.5	0.87	22.1	2	2.46	62.5	1.23	31.2

Reference Specifications: BS-4825-3



# 769 L MALE ELBOW

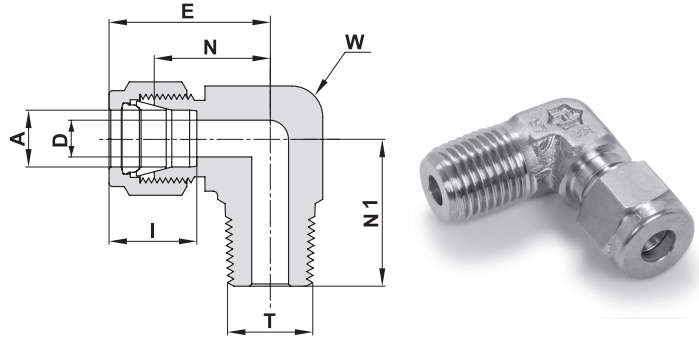

## TUBE (METRIC) MALE NPT THREAD

Ordering Information	A	T	D	W		N	E	N1	I
	Tube O.D.	(NPT)	mm	inch	mm	mm	mm	mm	mm
769L_3 X 1/8	3	1/8	2.4	7/16	11.1	17.0	23.6	17.8	12.9
769L_3 X 1/4	3	1/4	2.4	1/2	12.7	18.0	24.6	23.4	12.9
769L_4 X 1/8	4	1/8	2.4	1/2	12.7	18.8	25.4	18.8	13.7
769L_4 X 1/4	4	1/4	2.4	1/2	12.7	18.8	25.4	23.4	13.7
769L_6 X 1/8	6	1/8	4.8	1/2	12.7	19.6	27.0	18.8	15.3
769L_6 X 1/4	6	1/4	4.8	1/2	12.7	19.6	27.0	23.4	15.3
769L_6 X 3/8	6	3/8	4.8	11/16	17.5	22.4	29.8	26.2	15.3
769L_6 X 1/2	6	1/2	4.8	13/16	20.6	24.4	31.8	33.0	15.3
769L_8 X 1/8	8	1/8	4.8	9/16	14.3	21.3	28.8	19.8	16.2
769L_8 X 1/4	8	1/4	6.4	9/16	14.3	21.3	28.8	24.4	16.2
769L_8 X 3/8	8	3/8	6.4	11/16	17.5	23.1	30.6	26.2	16.2
769L_8 X 1/2	8	1/2	6.4	13/16	20.6	25.1	32.6	33.0	16.2
769L_10 X 1/8	10	1/8	4.8	11/16	17.5	23.9	31.5	21.6	17.2
769L_10 X 1/4	10	1/4	7.1	11/16	17.5	23.9	31.5	26.2	17.2
769L_10 X 3/8	10	3/8	7.9	11/16	17.5	23.9	31.5	26.2	17.2
769L_10 X 1/2	10	1/2	7.9	13/16	20.6	25.9	33.5	33.0	17.2
769L_12 X 1/8	12	1/8	4.8	13/16	20.6	25.9	36.0	23.6	22.8
769L_12 X 1/4	12	1/4	7.1	13/16	20.6	25.9	36.0	28.2	22.8
769L_12 X 3/8	12	3/8	9.5	13/16	20.6	25.9	36.0	28.2	22.8
769L_12 X 1/2	12	1/2	9.5	13/16	20.6	25.9	36.0	33.0	22.8
769L_12 X 3/4	12	3/4	9.5	1 1/16	27.0	29.7	39.8	36.8	22.8
769L_15 X 1/2	15	1/2	11.9	15/16	23.8	27.9	38.0	35.1	24.4
769L_16 X 3/8	16	3/8	9.5	15/16	23.8	27.9	38.0	30.2	24.4
769L_16 X 1/2	16	1/2	11.9	15/16	23.8	27.9	38.0	35.1	24.4
769L_16 X 3/4	16	3/4	12.7	1 1/16	27.0	29.7	39.8	36.8	24.4
769L_18 X 1/2	18	1/2	11.9	1 1/16	27.0	29.7	39.8	36.8	24.4
769L_18 X 3/4	18	3/4	15.1	1 1/16	27.0	29.7	39.8	36.8	24.4
769L_20 X 1/2	20	1/2	11.9	1 3/8	34.9	34.5	44.6	41.7	26.0
769L_20 X 3/4	20	3/4	15.9	1 3/8	34.9	34.5	44.6	41.7	26.0
769L_22 X 3/4	22	3/4	15.9	1 3/8	34.9	34.5	44.6	41.7	26.0
769L_22 X 1	22	1	18.3	1 3/8	34.9	34.5	44.6	46.5	26.0
769L_25 X 3/4	25	3/4	15.9	1 3/8	34.9	36.8	49.1	41.7	31.3
769L_25 X 1	25	1	21.8	1 3/8	34.9	36.8	49.1	46.5	31.3
769L_38 X 1 1/2	38*	1 1/2	33.7	-	55.0	56.4	84.0	60.4	49.4

\* Including low friction paste, (see page 98)

"D" - Dimension is minimum opening. Dimensions are for reference only and are subject to change without notice.

**769 L**  
**MALE ELBOW** (Cont'd)

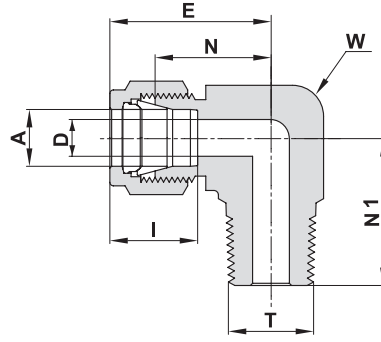

**TUBE (INCH) MALE NPT THREAD**

Ordering Information	A Tube O.D.		T (NPT)	D		W Wrench Flat		N		E		N1		I	
	inch	mm		inch	mm	inch	mm	inch	mm	inch	mm	inch	mm	inch	mm
769L_ 1/16 X 1/16	1/16	1.58	1/16	.05	1.27	7/16	11.1	.60	15.24	.75	19.05	.70	17.78	.34	8.6
769L_ 1/16 X 1/8	1/16	1.58	1/8	.05	1.27	7/16	11.1	.60	15.24	.75	19.05	.70	17.78	.34	8.6
769L_ 1/8 X 1/16	1/8	3.17	1/16	.09	2.28	7/16	11.1	.67	17.02	.93	23.62	.70	17.78	.50	12.7
769L_ 1/8 X 1/8	1/8	3.17	1/8	.09	2.28	7/16	11.1	.67	17.02	.93	23.62	.70	17.78	.50	12.7
769L_ 1/8 X 1/4	1/8	3.17	1/4	.09	2.28	1/2	12.7	.71	18.03	.97	24.64	.92	23.37	.50	12.7
769L_ 3/16 X 1/8	3/16	4.76	1/8	.12	3.04	1/2	12.7	.74	18.80	1.00	25.40	.74	18.80	.54	13.7
769L_ 3/16 X 1/4	3/16	4.76	1/4	.12	3.04	1/2	12.7	.74	18.80	1.00	25.40	.92	23.37	.54	13.7
769L_ 1/4 X 1/16	1/4	6.35	1/16	.12	3.04	1/2	12.7	.77	19.56	1.06	26.92	.74	18.80	.60	15.2
769L_ 1/4 X 1/8	1/4	6.35	1/8	.19	4.82	1/2	12.7	.77	19.56	1.06	26.92	.74	18.80	.60	15.2
769L_ 1/4 X 1/4	1/4	6.35	1/4	.19	4.82	1/2	12.7	.77	19.56	1.06	26.92	.92	23.37	.60	15.2
769L_ 1/4 X 3/8	1/4	6.35	3/8	.19	4.82	11/16	17.5	.88	22.35	1.17	29.71	1.03	26.16	.60	15.2
769L_ 1/4 X 1/2	1/4	6.35	1/2	.19	4.82	13/16	20.6	.96	24.38	1.25	31.75	1.30	33.02	.60	15.2
769L_ 5/16 X 1/8	5/16	7.93	1/8	.19	4.82	9/16	14.3	.84	21.34	1.13	28.70	.78	19.81	.64	16.2
769L_ 5/16 X 1/4	5/16	7.93	1/4	.25	6.35	9/16	14.3	.84	21.34	1.13	28.70	.96	24.38	.64	16.2
769L_ 5/16 X 3/8	5/16	7.93	3/8	.25	6.35	11/16	17.5	.91	23.11	1.20	30.48	1.03	26.16	.64	16.2
769L_ 3/8 X 1/8	3/8	9.52	1/8	.19	4.82	5/8	15.9	.91	23.11	1.20	30.48	.82	20.83	.66	16.8
769L_ 3/8 X 1/4	3/8	9.52	1/4	.28	7.11	5/8	15.9	.91	23.11	1.20	30.48	1.00	25.40	.66	16.8
769L_ 3/8 X 3/8	3/8	9.52	3/8	.28	7.11	11/16	17.5	.94	23.87	1.23	31.24	1.03	26.16	.66	16.8
769L_ 3/8 X 1/2	3/8	9.52	1/2	.28	7.11	13/16	20.6	1.02	25.90	1.31	33.28	1.30	33.02	.66	16.8
769L_ 3/8 X 3/4	3/8	9.52	3/4	.28	7.11	1 1/16	27.0	1.17	29.71	1.46	37.08	1.45	36.83	.66	16.8
769L_ 1/2 X 1/4	1/2	12.70	1/4	.28	7.11	13/16	20.6	1.02	25.90	1.42	36.07	1.11	28.19	.90	22.9
769L_ 1/2 X 3/8	1/2	12.70	3/8	.38	9.50	13/16	20.6	1.02	25.90	1.42	36.07	1.11	28.19	.90	22.9
769L_ 1/2 X 1/2	1/2	12.70	1/2	.41	10.41	13/16	20.6	1.02	25.90	1.42	36.07	1.30	33.02	.90	22.9
769L_ 1/2 X 3/4	1/2	12.70	3/4	.41	10.41	1 1/16	27.0	1.17	29.71	1.57	39.88	1.45	36.83	.90	22.9
769L_ 5/8 X 3/8	5/8	15.87	3/8	.38	9.61	15/16	23.8	1.10	27.94	1.50	38.10	1.19	30.23	.96	24.4
769L_ 5/8 X 1/2	5/8	15.87	1/2	.47	11.94	15/16	23.8	1.10	27.94	1.50	38.10	1.38	35.05	.96	24.4
769L_ 5/8 X 3/4	5/8	15.87	3/4	.50	12.70	1 1/16	27.0	1.17	29.71	1.57	39.88	1.45	36.83	.96	24.4
769L_ 3/4 X 1/2	3/4	19.05	1/2	.47	11.94	1 1/16	27.0	1.17	29.71	1.57	39.88	1.45	36.83	.96	24.4
769L_ 3/4 X 3/4	3/4	19.05	3/4	.62	15.74	1 1/16	27.0	1.17	29.71	1.57	39.88	1.45	36.83	.96	24.4
769L_ 7/8 X 3/4	7/8	22.22	3/4	.62	15.74	1 3/8	34.9	1.36	34.54	1.76	44.70	1.64	41.66	1.02	25.9
769L_ 1 X 3/4	1	25.40	3/4	.62	15.74	1 3/8	34.9	1.45	36.83	1.93	49.02	1.64	41.66	1.23	31.2
769L_ 1 X 1	1	25.40	1	.86	21.84	1 3/8	34.9	1.45	36.83	1.93	49.02	1.83	46.48	1.23	31.2
769L_ 1 1/4 X 1 1/4	1 1/4*	31.75	1 1/4	1.09	27.70	1 11/16	42.9	1.75	44.45	2.62	66.50	1.88	47.75	1.62	41.2
769L_ 1 1/2 X 1 1/2	1 1/2*	38.10	1 1/2	1.34	34.00	2	50.8	2.00	50.80	3.07	78.00	2.38	60.45	1.97	50.0
769L_ 2 X 2	2*	50.80	2	1.81	45.97	2 3/4	69.9	2.75	69.85	4.22	107.19	2.78	70.61	2.66	67.6

\* Including low friction paste, (see page 98)

"D" - Dimension is minimum opening. Dimensions are for reference only and are subject to change without notice.

**769 LA 45°  
MALE ELBOW 45°**

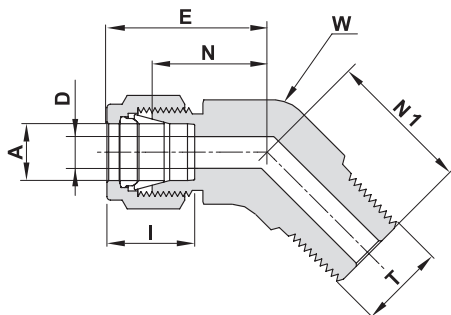

Ordering Information	A Tube O.D.		T (NPT)	D		W Wrench Flat		N		E		N1		I	
	inch	mm	inch	inch	mm	inch	mm	inch	mm	inch	mm	inch	mm	inch	mm
769LA SS 3/8 X 1/4	3/8	9.53	1/4	0.28	7.10	13/16	20.63	0.81	20.60	1.10	27.97	0.90	22.86	0.67	16.92
769LA SS 3/8 X 3/8	3/8	9.53	3/8	0.28	7.10	13/16	20.63	0.86	21.80	1.15	29.17	0.95	24.10	0.67	16.92
769LA SS 1/2 X 1/4	1/2	12.70	1/4	0.28	7.10	13/16	20.63	0.86	21.84	1.26	32.00	0.95	24.13	0.90	22.86
769LA SS 1/2 X 3/8	1/2	12.70	3/8	0.37	9.50	13/16	20.63	0.86	21.84	1.26	32.00	0.95	24.13	0.90	22.86

# 769 LR MALE ELBOW

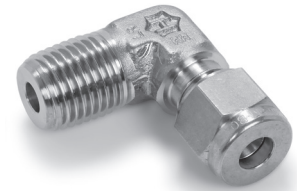
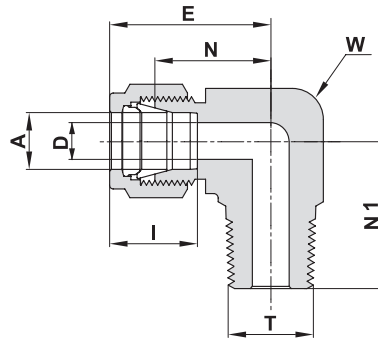

## TUBE (METRIC) ISO TAPERED THREAD

Ordering Information	A	T	D	W		N	E	N1	I
	Tube O.D.	(ISO)	mm	Wrench Flat	mm	mm	mm	mm	mm
	mm	inch	mm	inch	mm	mm	mm	mm	mm
769LR_ 3 X 1/8	3	R-1/8	2.4	7/16	11.1	17.0	23.6	17.8	12.9
769LR_ 3 X 1/4	3	R-1/4	2.4	1/2	12.7	18.0	24.6	23.4	12.9
769LR_ 4 X 1/8	4	R-1/8	2.4	1/2	12.7	18.8	25.4	18.8	13.7
769LR_ 4 X 1/4	4	R-1/4	2.4	1/2	12.7	18.8	25.4	23.4	13.7
769LR_ 6 X 1/8	6	R-1/8	4.8	1/2	12.7	19.6	27.0	18.8	15.3
769LR_ 6 X 1/4	6	R-1/4	4.8	1/2	12.7	19.6	27.0	23.4	15.3
769LR_ 6 X 3/8	6	R-3/8	4.8	11/16	17.5	22.4	29.8	26.2	15.3
769LR_ 6 X 1/2	6	R-1/2	4.8	13/16	20.6	24.4	31.8	33.0	15.3
769LR_ 8 X 1/8	8	R-1/8	4.8	9/16	14.3	21.3	28.8	19.8	16.2
769LR_ 8 X 1/4	8	R-1/4	6.4	9/16	14.3	21.3	28.8	24.4	16.2
769LR_ 8 X 3/8	8	R-3/8	6.4	11/16	17.5	23.1	30.6	26.2	16.2
769LR_ 8 X 1/2	8	R-1/2	6.4	13/16	20.6	25.1	32.6	33.0	16.2
769LR_ 10 X 1/8	10	R-1/8	4.8	11/16	17.5	23.9	31.5	21.6	17.2
769LR_ 10 X 1/4	10	R-1/4	7.1	11/16	17.5	23.9	31.5	26.2	17.2
769LR_ 10 X 3/8	10	R-3/8	7.9	11/16	17.5	23.9	31.5	26.2	17.2
769LR_ 10 X 1/2	10	R-1/2	7.9	13/16	20.6	25.9	33.5	33.0	17.2
769LR_ 12 X 1/8	12	R-1/8	4.8	13/16	20.6	25.9	36.0	23.6	22.8
769LR_ 12 X 1/4	12	R-1/4	7.1	13/16	20.6	25.9	36.0	28.2	22.8
769LR_ 12 X 3/8	12	R-3/8	9.5	13/16	20.6	25.9	36.0	28.2	22.8
769LR_ 12 X 1/2	12	R-1/2	9.5	13/16	20.6	25.9	36.0	33.0	22.8
769LR_ 12 X 3/4	12	R-3/4	9.5	1 1/16	27.0	29.7	39.8	36.8	22.8
769LR_ 14 X 1/2	14	R-1/2	11.0	15/16	23.8	27.9	38.0	35.0	24.4
769LR_ 15 X 1/2	15	R-1/2	11.9	15/16	23.8	27.9	38.0	35.1	24.4
769LR_ 16 X 3/8	16	R-3/8	9.5	15/16	23.8	27.9	38.0	30.2	24.4
769LR_ 16 X 1/2	16	R-1/2	11.9	15/16	23.8	27.9	38.0	35.1	24.4
769LR_ 18 X 1/2	18	R-1/2	11.9	1 1/16	27.0	29.7	39.8	36.8	24.4
769LR_ 18 X 3/4	18	R-3/4	15.1	1 1/16	27.0	29.7	39.8	36.8	24.4
769LR_ 20 X 1/2	20	R-1/2	11.9	1 3/8	34.9	34.5	44.6	41.7	26.0
769LR_ 20 X 3/4	20	R-3/4	15.9	1 3/8	34.9	34.5	44.6	41.7	26.0
769LR_ 22 X 3/4	22	R-3/4	15.9	1 3/8	34.9	34.5	44.6	41.7	26.0
769LR_ 22 X 1	22	R - 1	18.3	1 3/8	34.9	34.5	44.6	46.5	26.0
769LR_ 25 X 3/4	25	R-3/4	15.9	1 3/8	34.9	36.8	49.1	41.7	31.3
769LR_ 25 X 1	25	R - 1	21.8	1 3/8	34.9	36.8	49.1	46.5	31.3

### Reference Specifications:

- DIN - 2999
- BS - 21
- JIS - B0203
- ISO - 7/1-BSP-T

### Designation:

Marking LR on Flat

"D" - Dimension is minimum opening. Dimensions are for reference only and subject to change without notice.

Cont'd next page

**769 LR**  
**MALE ELBOW** (Cont'd)

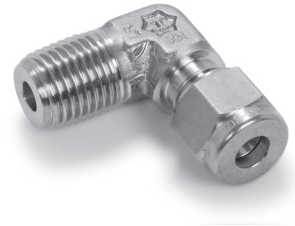
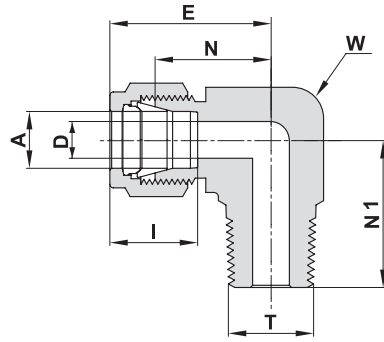

**TUBE (INCH) ISO TAPERED THREAD**

Ordering Information	A Tube O.D.		T (ISO)	D		W Wrench Flat		N		E		N1		I	
	inch	mm	inch	inch	mm	inch	mm	inch	mm	inch	mm	inch	mm	inch	mm
769LR_ 1/8 X 1/8	1/8	3.17	R-1/8	.09	2.28	7/16	11.1	.67	17.02	.93	23.62	.70	17.78	.50	12.7
769LR_ 1/8 X 1/4	1/8	3.17	R-1/4	.09	2.28	1/2	12.7	.71	18.03	.97	24.64	.92	23.37	.50	12.7
769LR_ 1/4 X 1/8	1/4	6.35	R-1/8	.19	4.82	1/2	12.7	.77	19.56	1.06	26.92	.74	18.80	.60	15.2
769LR_ 1/4 X 1/4	1/4	6.35	R-1/4	.19	4.82	1/2	12.7	.77	19.56	1.06	26.92	.92	23.37	.60	15.2
769LR_ 1/4 X 3/8	1/4	6.35	R-3/8	.19	4.82	11/16	17.5	.88	22.35	1.17	29.71	1.03	26.16	.60	15.2
769LR_ 1/4 X 1/2	1/4	6.35	R-1/2	.19	4.82	13/16	20.6	.96	24.38	1.25	31.75	1.30	33.02	.60	15.2
769LR_ 5/16 X 1/4	5/16	7.93	R-1/4	.25	6.35	9/16	14.3	.84	21.34	1.13	28.70	.96	24.38	.64	16.2
769LR_ 3/8 X 1/8	3/8	9.52	R-1/8	.19	4.82	5/8	15.9	.91	23.11	1.20	30.48	.82	20.83	.66	16.8
769LR_ 3/8 X 1/4	3/8	9.52	R-1/4	.28	7.11	5/8	15.9	.91	23.11	1.20	30.48	1.00	25.40	.66	16.8
769LR_ 3/8 X 3/8	3/8	9.52	R-3/8	.28	7.11	11/16	17.5	.94	23.87	1.23	31.24	1.03	26.16	.66	16.8
769LR_ 1/2 X 1/4	1/2	12.70	R-1/4	.28	7.11	13/16	20.6	1.02	25.90	1.42	36.07	1.11	28.19	.90	22.9
769LR_ 1/2 X 3/8	1/2	12.70	R-3/8	.38	9.50	13/16	20.6	1.02	25.90	1.42	36.07	1.11	28.19	.90	22.9
769LR_ 1/2 X 1/2	1/2	12.70	R-1/2	.41	10.41	13/16	20.6	1.02	25.90	1.42	36.07	1.30	33.02	.90	22.9
769LR_ 3/4 X 1/2	3/4	19.05	R-1/2	.47	11.94	1 1/16	27.0	1.17	29.71	1.57	39.88	1.45	36.83	.96	24.4
769LR_ 1 X 1	1	25.40	R-1	.86	21.84	1 3/8	34.9	1.45	36.83	1.93	49.02	1.83	46.48	1.23	31.2

**Reference Specifications:**  
 DIN - 2999  
 BS - 21  
 JIS - B0203  
 ISO - 7/1-BSP-T

**Designation:**  
 Marking LR on Flat

# POSITIONABLES PER SAE

J1926 AND MS 16142

## 769 LOB MALE ELBOW POS

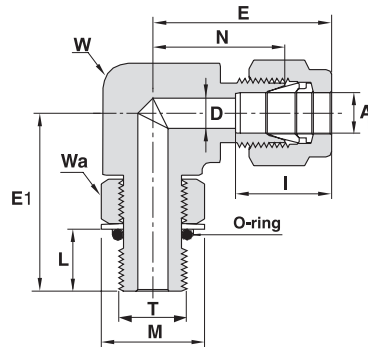

### TUBE TO SAE/MS STRAIGHT THREAD BOSS (POSITIONABLE)\*

Ordering Information	A Tube O.D.		T SAE/MS	D		W Wrench Flat		Wa Hex. Flat	N		E		E1		L		M		I		O-ring**
	inch	mm	inch	inch	mm	inch	mm	inch	inch	mm	inch	mm	inch	mm	inch	mm	inch	mm	inch	mm	Dash No.
769LOB SS 1/4 X 7/16-20 POS.	1/4	6.35	7/16-20	.19	4.8	1/2	12.7	9/16	.83	21.10	1.12	28.45	1.12	28.45	.39	9.9	.65	16.5	.60	15.2	-904
769LOB SS 1/4 X 9/16-18 POS.	1/4	6.35	9/16-18	.19	4.8	5/8	15.9	11/16	.91	23.11	1.20	30.48	1.27	32.26	.44	11.2	.79	20.1	.60	15.2	-906
769LOB SS 3/8 X 7/16-20 POS.	3/8	9.52	7/16-20	.20	5.1	5/8	15.9	9/16	.97	24.64	1.26	32.00	1.12	28.45	.39	9.9	.65	16.5	.66	16.8	-904
769LOB SS 3/8 X 9/16-18 POS.	3/8	9.52	9/16-18	.28	7.1	5/8	15.9	11/16	.97	24.64	1.26	32.00	1.27	32.26	.44	11.2	.79	20.1	.66	16.8	-906
769LOB SS 3/8 X 3/4-16 POS.	3/8	9.52	3/4-16	.28	7.1	13/16	20.6	7/8	1.08	27.43	1.37	34.80	1.49	37.85	.50	12.7	1.01	25.7	.66	16.8	-908
769LOB SS 1/2 X 9/16-18 POS.	1/2	12.70	9/16-18	.28	7.1	13/16	20.6	11/16	1.08	27.43	1.48	37.59	1.38	35.05	.44	11.2	.79	20.1	.90	22.9	-906
769LOB SS 1/2 X 3/4-16 POS.	1/2	12.70	3/4-16	.41	10.4	13/16	20.6	7/8	1.08	27.43	1.48	37.59	1.49	37.85	.50	12.7	1.01	25.7	.90	22.9	-908
769LOB SS 3/4 X 1 1/16-12 POS.	3/4	19.05	1 1/16-12	.62	15.8	1 1/16	27.0	1 1/4	1.23	31.24	1.63	41.40	1.92	48.77	.66	16.8	1.44	36.7	.96	24.4	-912
769LOB SS 1 X 1 1/16-12 POS.	1	25.40	1 1/16-12	.62	15.8	1 3/8	34.9	1 1/4	1.51	38.35	1.99	50.55	2.05	52.07	.66	16.8	1.44	36.7	1.23	31.2	-912
769LOB SS 1 X 1 5/16-12 POS.	1	25.40	1 5/16-12	.88	22.3	1 3/8	34.9	1 1/2	1.51	38.35	1.99	50.55	2.11	53.59	.66	16.8	1.73	44.0	1.23	31.2	-916

\* Per SAE J1926 and MS 16142. See page 53 for mounting dimensions.

# DIMENSIONS

FOR SAE J1926 & MS 16142 BOSS

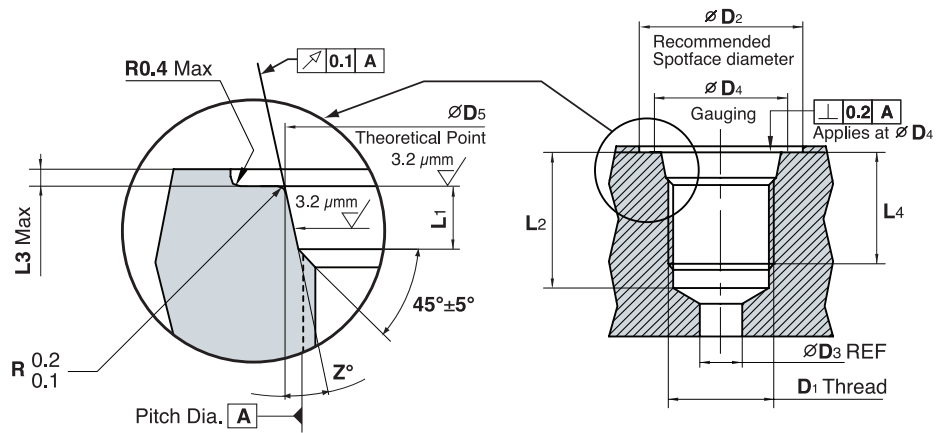

## MOUNTING DIMENSIONS FOR O-SEAL CONNECTORS (SAE/MS)

TUBE O.D.		D1 Thread Size	D2 Min Diameter ±0.05	D3 Min Diameter	D4 Min	D5 ±0.05	L1 ±0.20	L2 Min	L3 Max	L4 Min Full Thread	°Z ±1
inch	mm	inch	mm	mm	mm	mm	mm	mm	mm	mm	
1/8	3.17	5/16 - 24 UNF - 2B	17	1.6	11	9.15	2.1	12	1.6	10	12
3/16	4.76	3/8 - 24 UNF - 2B	19	3.5	13	10.75	2.1	12	1.6	10	12
1/4	6.35	7/16 - 20 UNF - 2B	21	4.5	15	12.45	2.6	14	1.6	11.5	12
5/16	7.93	1/2 - 20 UNF - 2B	23	6	16	14.05	2.6	14	1.6	11.5	12
3/8	9.52	9/16 - 18 UNF - 2B	25	7.5	18	15.70	2.7	15.5	1.6	12.7	12
1/2	12.70	3/4 - 16 UNF - 2B	30	10	22	20.65	2.7	17.5	2.4	14.3	15
5/8	15.87	7/8 - 14 UNF - 2B	34	12.5	26	24	2.7	20	2.4	16.7	15
3/4	19.05	1 1/16 - 12 UNF - 2B	41	16	32	29.2	3.5	23	2.4	19	15
7/8	22.22	1 3/16 - 12 UN - 2B	45	18	35	32.4	3.5	23	2.4	19	15
1	25.40	1 5/16 - 12 UN - 2B	49	21	38	35.55	3.5	23	3.2	19	15
1 1/4	31.75	1 5/8 - 12 UN - 2B	58	27	48	43.55	3.5	23	3.2	19	15
1 1/2	38.10	1 7/8 - 12 UN - 2B	65	33	54	49.9	3.5	23	3.2	19	15
2	50.80	2 1/2 - 12 UN - 2B	88	45	70	65.75	3.5	23	3.2	19	15

## INSTALLATION INSTRUCTIONS

Figure 1	Figure 2	Figure 3	Figure 4
<b>Locking backed off</b>	<b>Fitting install hand tight</b>	<b>Fittings backed-off for alignment (turn maximum 1)</b>	<b>Fitting locknut tightly to appropriate torque</b>
Lubricate the O-ring by inserting it into the groove adjacent to the face of the metal back-up washer which is assembled at the extreme end of the groove as shown in Figure 1.	Install the fitting into the S.A.E. straight thread boss, Figure 2, until the metal back-up washer contacts the face of the boss as shown in Figure 2.	Position the fitting by turning it counter clockwise up to a maximum of one turn (see Figure 3).	Holding the pad of the fitting with a spanner, tighten the locknut and washer against the face as shown in Figure 4.

Dimensions are for reference only and subject to change without notice.



# POSITIONABLES

ISO PARALLEL THREAD

## 769 LG MALE ELBOW

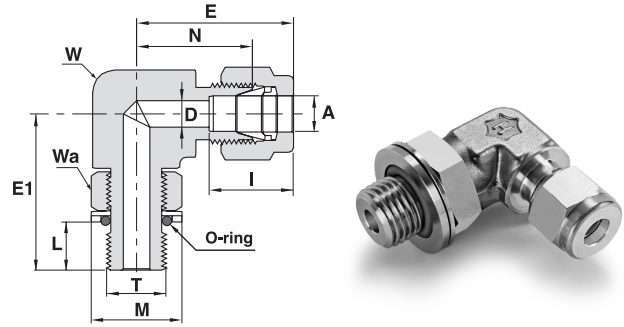

TUBE (METRIC) TO ISO PARALLEL THREAD (POSITIONABLE)\*

Ordering Information	A Tube O.D.		T (ISO)	D		W Wrench Flat		Wa Hex. Flat	N		E	E1	L		M	I	O-ring**
	mm	inch	inch	mm	mm	inch	mm	inch	mm	mm	mm	mm	mm	mm	mm	mm	Dash No.
769LG SS 6 X 1/8 POS.	6		G-1/8-28	4.0		1/2	12.7	9/16	19.6		27.0	26.4	8.1	17.3		15.3	***
769LG SS 6 X 1/4 POS.	6		G-1/4-19	4.8		5/8	15.9	3/4	21.6		29.0	32.2	9.1	22.9		15.3	-111
769LG SS 8 X 1/8 POS.	8		G-1/8-28	4.0		5/8	15.9	9/16	21.3		28.8	27.4	8.1	17.3		16.2	***
769LG SS 8 X 1/4 POS.	8		G-1/4-19	5.9		5/8	15.9	3/4	22.4		29.9	32.2	9.1	22.9		16.2	-111
769LG SS 10 X 1/4 POS.	10		G-1/4-19	5.9		13/16	20.6	3/4	25.9		33.5	35.0	9.1	22.9		17.2	-111
769LG SS 10 X 3/8 POS.	10		G-3/8-19	7.9		13/16	20.6	7/8	25.9		33.5	37.1	9.4	26.4		17.2	-113
769LG SS 12 X 1/4 POS.	12		G-1/4-19	5.9		13/16	20.6	3/4	25.9		36.0	35.0	9.1	22.9		22.8	-111
769LG SS 12 X 3/8 POS.	12		G-3/8-19	7.9		13/16	20.6	7/8	25.9		36.0	37.1	9.4	26.4		22.8	-113
769LG SS 12 X 1/2 POS.	12		G-1/2-14	9.5		15/16	23.8	1 1/16	27.9		38.0	43.4	13.0	32.0		22.8	-593

TUBE (INCH) TO ISO PARALLEL THREAD (POSITIONABLE)\*

Ordering Information	A Tube O.D.		T (ISO)	D		W Wrench Flat		Wa Hex. Flat	N		E	E1	L		M	I	O-ring**				
	inch	mm	inch	inch	mm	inch	mm	inch	inch	mm	inch	mm	inch	mm	inch	mm	Dash No.				
769LG SS 1/4 X 1/8 POS.	1/4	6.35	G-1/8-28	.16	4.0	1/2	12.7	9/16	.77	19.60	1.06	26.9	1.04	26.4	.32	8.1	.68	17.3	.60	15.2	***
769LG SS 1/4 X 1/4 POS.	1/4	6.35	G-1/4-19	.19	4.8	5/8	15.9	3/4	.85	21.60	1.14	28.9	1.27	32.2	.36	9.1	.90	22.9	.60	15.2	-111
769LG SS 1/4 X 1/2 POS.	1/4	6.35	G-1/2-14	.19	4.8	15/16	23.8	1 1/16	.96	24.38	1.25	31.8	1.71	43.4	.51	13.0	1.26	32.0	.60	15.2	-593
769LG SS 3/8 X 1/4 POS.	3/8	9.52	G-1/4-19	.23	5.9	5/8	15.9	3/4	.91	23.11	1.20	30.5	1.27	32.2	.36	9.1	.90	22.9	.66	16.8	-111
769LG SS 3/8 X 3/8 POS.	3/8	9.52	G-3/8-19	.28	7.1	13/16	20.6	7/8	1.02	25.91	1.31	33.3	1.46	37.1	.37	9.4	1.04	26.4	.66	16.8	-113
769LG SS 1/2 X 1/4 POS.	1/2	12.70	G-1/4-19	.23	5.9	13/16	20.6	3/4	1.02	25.91	1.42	36.1	1.27	32.2	.36	9.1	.90	22.9	.90	22.9	-111
769LG SS 1/2 X 3/8 POS.	1/2	12.70	G-3/8-19	.31	7.9	13/16	20.6	7/8	1.02	25.91	1.42	36.1	1.46	37.1	.37	9.4	1.04	26.4	.90	22.9	-113
769LG SS 1/2 X 1/2 POS.	1/2	12.70	G-1/2-14	.41	10.4	15/16	23.8	1 1/16	1.10	27.94	1.50	38.1	1.71	43.4	.51	13.0	1.26	32.0	.90	22.9	-593
769LG SS 5/8 X 1/2 POS.	5/8	15.87	G-1/2-14	.47	11.9	15/16	23.8	1 1/16	1.10	27.94	1.50	38.1	1.71	43.4	.51	13.0	1.26	32.0	.96	24.4	-593

**Reference Specifications:**

DIN - ISO 228/1  
BS - 2779  
JIS - B0202  
ISO - 228/1-BSP-P

\*\*O-rings used are Fluorocarbon FKM 90 Durometer. Other O-ring materials are available on request.

\*\*\*Not standard O-ring size.

"D" - Dimension is minimum opening. Dimensions are for reference only and subject to change without notice.



## POSITIONABLES PER SAE

J1926 AND MS 16142

### 769 LOB 45° MALE ELBOW 45° POS

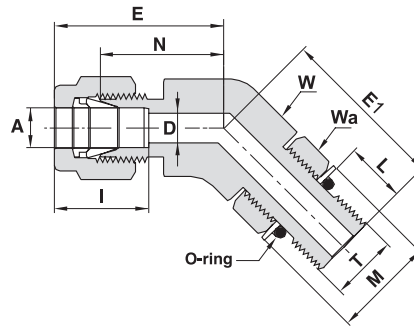

#### TUBE TO SAE/MS STRAIGHT THREAD BOSS (POSITIONABLE)\*

Ordering Information	A Tube O.D.		T SAE/MS	D		W Wrench Flat		Wa Hex. Flat	N		E		E1		L		M		I	O-ring**	
	inch	mm	inch	inch	mm	inch	mm	inch	inch	mm	inch	mm	inch	mm	inch	mm	inch	mm	inch	mm	Dash No.
769LAOB SS 1/4 X 7/16-20 POS.	1/4	6.35	7/16-20	.19	4.8	9/16	14.3	9/16	.72	18.29	1.01	25.65	1.01	25.65	.39	9.9	.65	16.5	.60	15.2	-904
769LAOB SS 3/8 X 9/16-18 POS.	3/8	9.52	9/16-18	.28	7.1	13/16	20.6	11/16	.81	20.57	1.10	27.94	1.06	27.00	0.40	10.2	.79	20.1	.66	16.8	-906

#### Reference Specifications:

\* Per SAE J1926 and MS 16142. See page 53 for mounting dimensions.

\*\* Standard O-rings materials are Fluorocarbon FKM 90 Durometer. Other O-ring materials are available upon request.

"D" - Dimension is minimum opening. Dimensions are for reference only, and are subject to change without notice.

### 769 LG 45° MALE ELBOW 45° POS

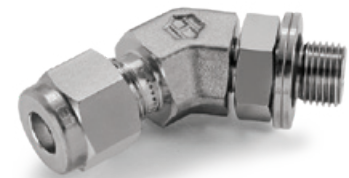
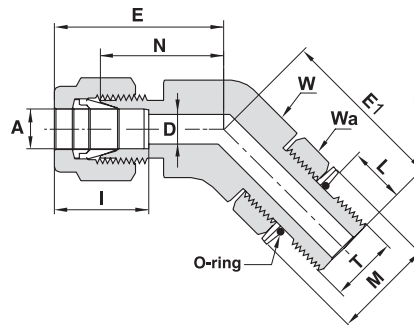

#### TUBE TO (METRIC) TO ISO PARALEL THREAD (POSITIONABLE)\*

Ordering Information	A Tube O.D.		T (ISO)	D	W Wrench Flat		Wa Hex. Flat	N	E	E1	L	M	I	O-ring**
	inch	mm	inch	mm	inch	mm	inch	mm	mm	mm	mm	mm	mm	Dash No.
769LAG SS 6 X 1/8 POS.		6	G-1/8-28	4.0	9/16	14.3	9/16	17.5	24.9	24.0	8.1	8.1	15.3	***

#### TUBE TO (INCH) TO ISO PARALEL THREAD (POSITIONABLE)\*

Ordering Information	A Tube O.D.		T (ISO)	D	W Wrench Flat		Wa Hex. Flat	N	E	E1	L	M	I	O-ring**							
	inch	mm	inch	inch	mm	inch	mm	inch	mm	inch	mm	inch	mm	Dash No.							
769LAG SS 1/4 X 1/8 POS.	1/4	6.35	G-1/8-28	.16	4.0	9/16	14.3	9/16	69.	17.5	.98	24.0	.94	24.0	.32	8.1	0.68	17.3	.60	15.2	***

#### Reference Specifications:

DIN - ISO 228/1

BS - 2779

JIS - B0202

ISO - 228/1-BSP-P

\*\*Standard O-rings materials are Fluorocarbon FKM 90 Durometer. Other O-ring materials are available upon request.

\*\*\*Not standard O-ring size

"D" - Dimension is minimum opening. Dimensions are for reference only and subject to change without notice.

## 769 LN MALE PIPE WELD ELBOW

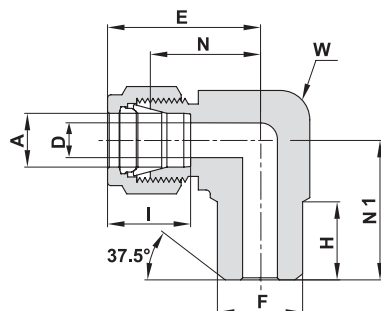

### TUBE (INCH)

Ordering Information	A Tube O.D.		F Pipe Size		D		W Wrench Flat		N		H		E		N1		I	
	inch	mm	inch	mm	inch	mm	inch	mm	inch	mm	inch	mm	inch	mm	inch	mm	inch	mm
769LN _ 1/4 X 1/8	1/4	6.35	1/8	10.30	.19	4.82	1/2	12.7	.77	19.56	.38	9.65	1.06	26.92	.74	18.8	.60	15.2
769LN _ 1/4 X 1/4	1/4	6.35	1/4	13.70	.19	4.82	1/2	12.7	.77	19.56	.56	14.22	1.06	26.92	.92	23.37	.60	15.2
769LN _ 3/8 X 1/4	3/8	9.52	1/4	13.70	.28	7.11	5/8	15.9	.91	23.11	.56	14.22	1.20	30.48	1.00	25.40	.66	16.8
769LN _ 1/2 X 1/2	1/2	12.70	1/2	21.34	.41	10.41	13/16	20.6	1.02	25.90	.75	19.05	1.42	36.06	1.30	33.02	.90	22.9
769LN _ 3/4 X 3/4	3/4	19.05	3/4	26.67	.62	15.75	1 1/16	27.0	1.17	29.72	.75	19.05	1.57	39.88	1.45	36.83	.96	24.4

### Designation:

Marking LN on Flat

"D" - Dimension is minimum opening. Dimensions are for reference only and are subject to change without notice.

## 769 LW TUBE SOCKET WELD ELBOW

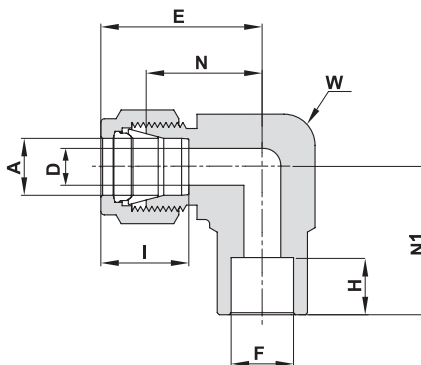

### TUBE (INCH)

Ordering Information	A Tube O.D.		F Tube O.D.		D		W Wrench Flat		N		H		E		N1		I	
	inch	mm	inch	mm	inch	mm	inch	mm	inch	mm	inch	mm	inch	mm	inch	mm	inch	mm
769LW _ 1/4 X 1/4	1/4	6.35	1/4	6.35	.19	4.82	1/2	12.7	.77	19.60	.31	7.87	1.06	26.98	.77	19.60	.60	15.2
769LW _ 3/8 X 3/8	3/8	9.52	3/8	9.52	.28	7.11	5/8	15.9	.91	23.11	.38	9.65	1.20	30.98	.91	23.11	.66	16.8
769LW _ 1/2 X 1/2	1/2	12.70	1/2	12.70	.41	10.41	15/16	23.8	1.02	25.90	.50	12.70	1.42	36.06	1.02	25.90	.90	22.9
769LW _ 3/4 X 3/4	3/4	19.05	3/4	19.05	.62	15.74	1 1/16	27.0	1.17	29.71	.56	14.22	1.57	39.87	1.17	29.71	.96	24.4
769LW _ 1 X 1	1	25.40	1	25.40	.88	22.35	1 3/8	34.9	1.45	36.83	.75	19.05	1.93	49.02	1.45	36.83	1.23	31.2

### Designation:

Marking LW on flat

## 769 LT REDUCING ELBOW

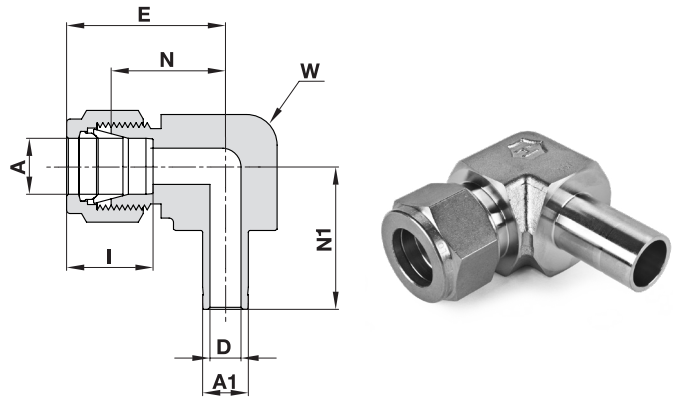

### TUBE (METRIC) TO STUB (METRIC)

Ordering Information	A Tube O.D.		A1 .Tube O.D		D		W Wrench Flat		N		E		N1		I	
	mm	mm	mm	mm	mm	mm	inch	mm	mm	mm	mm	mm	mm	mm	mm	
769LT_ 6 X 6	6	6	6	6	4.0	4.0	1/2	12.7	19.6	19.6	27.0	27.0	23.8	23.8	15.3	15.3
769LT_ 12 X 12	12	12	12	12	8.8	8.8	1 1/8	28.6	27.9	27.9	38.0	38.0	40.4	40.4	22.8	22.8
769LT_ 15 X 15	15	15	15	15	12.0	12.0	1 1/8	28.6	27.9	27.9	38.0	38.0	41.0	41.0	24.4	24.4
769LT_ 22 X 22	22	22	22	22	18.3	18.3	1 3/8	34.9	34.5	34.5	44.6	44.6	50.0	50.0	26.0	26.0

### TUBE (INCH) TO STUB (INCH)

Ordering Information	A Tube O.D.		A1 .Tube O.D		D		W Wrench Flat		N		E		N1		I	
	inch	mm	inch	mm	inch	mm	inch	mm	inch	mm	inch	mm	inch	mm	inch	mm
769LT_ 1/4 X 3/8	1/4	6.35	3/8	9.52	.19	4.82	5/8	15.9	.91	23.1	1.20	30.5	1.24	31.5	.60	15.2
769LT_ 1/4 X 1/2	1/4	6.35	1/2	12.7	.19	4.82	5/8	15.9	.91	23.1	1.20	30.5	1.28	32.5	.60	15.2

# 770 L FEMALE ELBOW

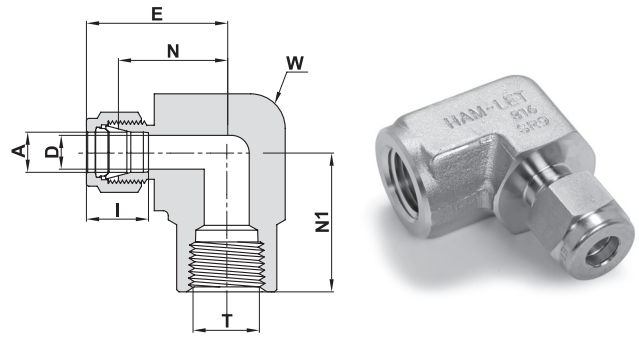

## TUBE (METRIC) TO FEMALE NPT THREAD

Ordering Information	A Tube O.D.		T (NPT)	D		W Wrench Flat		N		E		N1		I	
	mm	inch	inch	mm	inch	mm	inch	mm	mm	mm	mm	mm	mm	mm	mm
770L_ 6 X 1/8	6	1/8	1/8	4.8	1/2	12.7	19.6	27.0	19.0	15.3					
770L_ 6 X 1/4	6	1/4	1/4	4.8	11/16	17.5	22.4	29.8	22.4	15.3					
770L_ 6 X 1/2	6	1/2	1/2	4.8	1 1/16	27.0	27.2	34.6	28.4	15.3					
770L_ 8 X 1/4	8	1/4	1/4	6.4	11/16	17.5	23.1	30.6	22.4	16.2					
770L_ 10 X 1/8	10	1/8	1/8	7.9	11/16	17.5	23.9	31.5	19.0	17.2					
770L_ 10 X 1/4	10	1/4	1/4	7.9	13/16	20.6	25.9	33.5	22.4	17.2					
770L_ 12 X 1/4	12	1/4	1/4	9.5	13/16	20.6	25.9	36.0	22.4	22.8					
770L_ 12 X 1/2	12	1/2	1/2	9.5	1 1/16	27.0	28.7	38.8	28.4	22.8					
770L_ 16 X 1/2	16	1/2	1/2	12.7	1 1/16	27.0	29.7	39.8	28.4	24.4					

## TUBE (INCH) TO FEMALE NPT THREAD

Ordering Information	A Tube O.D.		T (NPT)	D		W Wrench Flat		N		E		N1		I	
	inch	mm	inch	inch	mm	inch	mm	inch	mm	inch	mm	inch	mm	inch	mm
770L_ 1/8 X 1/8	1/8	3.17	1/8	.09	2.28	1/2	12.7	.71	18.03	.97	24.64	.75	19.05	.50	12.7
770L_ 1/8 X 1/4	1/8	3.17	1/4	.09	2.28	11/16	17.5	.82	20.80	1.08	27.43	.88	22.40	.50	12.7
770L_ 3/16 X 1/8	3/16	4.76	1/8	.12	3.04	1/2	12.7	.74	18.80	1.00	25.40	.75	19.05	.54	13.7
770L_ 1/4 X 1/8	1/4	6.35	1/8	.19	4.82	1/2	12.7	.77	19.55	1.06	26.92	.75	19.05	.60	15.2
770L_ 1/4 X 1/4	1/4	6.35	1/4	.19	4.82	11/16	17.5	.88	22.40	1.17	29.72	.88	22.40	.60	15.2
770L_ 1/4 X 3/8	1/4	6.35	3/8	.19	4.82	15/16	23.8	.96	24.38	1.25	31.75	.88	22.40	.60	15.2
770L_ 1/4 X 1/2	1/4	6.35	1/2	.19	4.82	1 1/16	27.0	1.07	27.18	1.36	34.54	1.12	28.45	.60	15.2
770L_ 5/16 X 1/8	5/16	7.93	1/8	.25	6.35	9/16	14.3	.84	21.30	1.13	28.70	.75	19.05	.64	16.2
770L_ 5/16 X 1/4	5/16	7.93	1/4	.25	6.35	11/16	17.5	.91	23.11	1.20	30.48	.88	22.40	.64	16.2
770L_ 3/8 X 1/8	3/8	9.52	1/8	.28	7.11	5/8	15.9	.91	23.11	1.20	30.48	.75	19.05	.66	16.8
770L_ 3/8 X 1/4	3/8	9.52	1/4	.28	7.11	11/16	17.5	0.94	23.87	1.23	31.24	.88	22.40	.66	16.8
770L_ 3/8 X 3/8	3/8	9.52	3/8	.28	7.11	15/16	23.8	1.02	25.90	1.31	33.27	.88	22.40	.66	16.8
770L_ 3/8 X 1/2	3/8	9.52	1/2	.28	7.11	1 1/16	27.0	1.13	28.70	1.42	36.07	1.12	28.45	.66	16.8
770L_ 1/2 X 1/4	1/2	12.70	1/4	.41	10.41	13/16	20.6	1.02	25.90	1.42	36.07	.88	22.40	.90	22.9
770L_ 1/2 X 3/8	1/2	12.70	3/8	.41	10.41	15/16	23.8	1.02	25.90	1.42	36.07	.88	22.40	.90	22.9
770L_ 1/2 X 1/2	1/2	12.70	1/2	.41	10.41	1 1/16	27.0	1.13	28.70	1.53	36.86	1.12	28.45	.90	22.9
770L_ 5/8 X 3/8	5/8	15.87	3/8	.50	12.70	15/16	23.8	1.10	27.90	1.50	38.10	.88	22.40	.96	24.4
770L_ 5/8 X 1/2	5/8	15.87	1/2	.50	12.70	1 1/16	27.0	1.17	29.70	1.57	39.86	1.12	28.45	.96	24.4
770L_ 3/4 X 1/2	3/4	19.05	1/2	.62	15.74	1 1/16	27.0	1.17	29.70	1.57	39.86	1.12	28.45	.96	24.4
770L_ 3/4 X 3/4	3/4	19.05	3/4	.62	15.74	1 3/8	34.9	1.36	34.54	1.76	44.70	1.25	31.75	.96	24.4
770L_ 7/8 X 3/4	7/8	22.22	3/4	.72	18.28	1 3/8	34.9	1.36	34.54	1.76	44.70	1.25	31.75	1.02	25.9
770L_ 1 X 3/4	1	25.40	3/4	.88	22.35	1 3/8	34.9	1.45	36.83	1.93	49.02	1.25	31.75	1.23	31.2
770L_ 1 X 1	1	25.40	1	.88	22.35	1 11/16	42.9	1.63	41.40	2.11	53.59	1.50	38.10	1.23	31.2

"D" - Dimension is minimum opening. Dimensions are for reference only and subject to change without notice.

## 771 L MALE RUN TEE

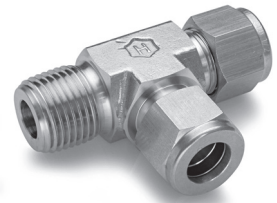
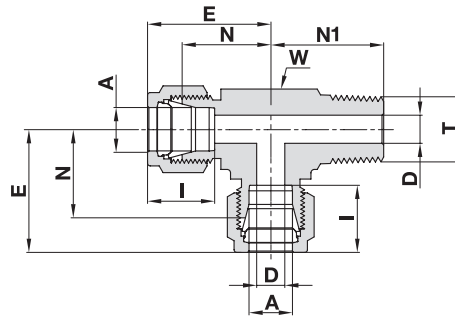

### TUBE (METRIC) TO MALE NPT THREAD

Ordering Information	A Tube O.D.		T (NPT)	D		W Wrench Flat		N		E		N1		I	
	mm	inch	inch	mm	inch	inch	mm	mm	mm	mm	mm	mm	mm	mm	
771L_6 X 1/8	6	1/8	1/8	4.8	1/2	12.7	19.6	27.0	18.8	15.3					
771L_6 X 1/4	6	1/4	1/4	4.8	1/2	12.7	19.6	27.0	23.4	15.3					
771L_8 X 1/8	8	1/8	1/8	4.8	5/8	15.9	22.4	29.0	20.8	16.2					
771L_8 X 1/4	8	1/4	1/4	6.4	5/8	15.9	22.4	29.9	25.4	16.2					
771L_10 X 1/4	10	1/4	1/4	7.1	13/16	20.6	25.9	33.5	28.2	17.2					
771L_12 X 1/4	12	1/4	1/4	7.1	13/16	20.6	25.9	36.0	28.2	22.8					
771L_12 X 3/8	12	3/8	3/8	9.5	13/16	20.6	25.9	36.0	28.2	22.8					
771L_12 X 1/2	12	1/2	1/2	9.5	13/16	20.6	25.9	36.0	33.0	22.8					
771L_16 X 1/2	16	1/2	1/2	11.9	15/16	23.8	27.9	38.0	35.0	24.4					

### TUBE (INCH) TO MALE NPT THREAD

Ordering Information	A Tube O.D.		T (NPT)	D		W Wrench Flat		N		E		N1		I	
	inch	mm	inch	inch	mm	inch	mm	inch	mm	inch	mm	inch	mm	inch	mm
771L_1/8 X 1/8	1/8	3.17	1/8	.09	2.28	7/16	11.1	.67	17.02	.93	23.62	.70	17.78	.50	12.7
771L_1/8 X 1/4	1/8	3.17	1/4	.09	2.28	1/2	12.7	.71	18.03	.97	24.64	.92	23.40	.50	12.7
771L_3/16 X 1/8	3/16	4.76	1/8	.12	3.05	7/16	11.1	.70	17.78	.96	24.38	.70	17.78	.54	13.7
771L_1/4 X 1/8	1/4	6.35	1/8	.19	4.82	1/2	12.7	.77	19.56	1.06	26.92	.74	18.8	.60	15.2
771L_1/4 X 1/4	1/4	6.35	1/4	.19	4.82	1/2	12.7	.77	19.56	1.06	26.92	.92	23.37	.60	15.2
771L_5/16 X 1/8	5/16	7.93	1/8	.19	4.82	5/8	15.9	.88	22.35	1.17	29.71	.82	20.83	.64	16.2
771L_3/8 X 1/4	3/8	9.52	1/4	.28	7.11	5/8	15.9	.91	23.11	1.20	30.48	1.00	25.40	.66	16.8
771L_3/8 X 3/8	3/8	9.52	3/8	.28	7.11	13/16	20.6	1.02	25.91	1.31	33.27	1.11	28.19	.66	16.8
771L_1/2 X 3/8	1/2	12.70	3/8	.38	9.5	13/16	20.6	1.02	25.91	1.42	36.07	1.11	28.19	.90	22.9
771L_1/2 X 1/2	1/2	12.70	1/2	.41	10.41	13/16	20.6	1.02	25.91	1.42	36.07	1.30	33.00	.90	22.9
771L_5/8 X 1/2	5/8	15.87	1/2	.47	11.94	15/16	23.8	1.10	27.94	1.50	38.1	1.38	35.05	.96	24.4
771L_3/4 X 3/4	3/4	19.05	3/4	.62	15.75	1 1/16	27.0	1.17	29.72	1.57	39.88	1.45	36.83	.96	24.4

## POSITIONABLES

PER SAE J1926 AND MS 16142

### 771 LOB MALE RUN TEE POS

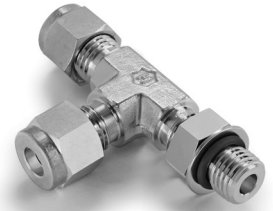
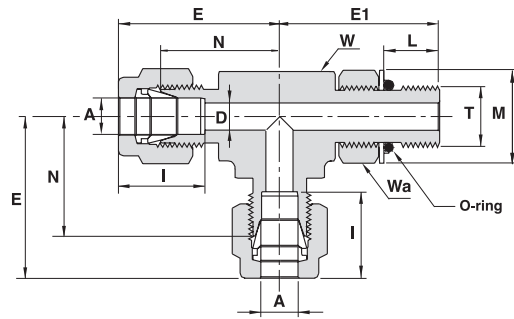

#### TUBE TO SAE/MS STRAIGHT THREAD BOSS (POSITIONABLE)\*

Ordering Information	A Tube O.D.		T SAE/MS	D		W Wrench Flat		Wa Hex. Flat	N		E		E1		L		M		I	O-ring**	
	inch	mm	inch	inch	mm	inch	mm	inch	inch	mm	inch	mm	inch	mm	inch	mm	inch	mm	inch	mm	Dash No.
771LOB SS 1/4 X 7/16-20 POS.	1/4	6.35	7/16-20	.19	4.8	1/2	12.7	9/16	.83	21.10	1.12	28.45	1.12	28.45	.39	9.9	.65	16.5	.60	15.2	-904
771LOB SS 3/8 X 9/16-18 POS.	3/8	9.52	9/16-18	.28	7.1	5/8	15.9	11/16	.97	24.64	1.26	32.00	1.27	32.26	.44	11.2	.79	20.1	.66	16.8	-906

\*Per SAE J1926 and MS 16142. (See page 53) for mounting dimensions.

\*\*O-rings used are Fluorocarbon FKM 90 Durometer. Other O-ring materials are available on request.

### 771 LG MALE RUN TEE POS

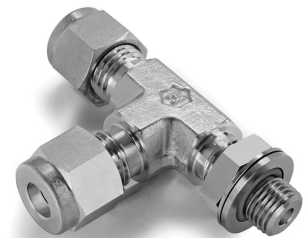
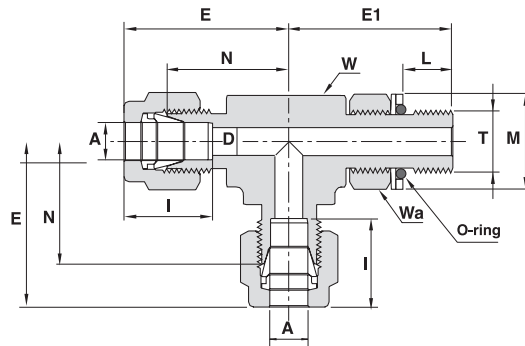

#### TUBE (METRIC) TO ISO PARALLEL THREAD (POSITIONABLE)\*

Ordering Information	A Tube O.D.		T (ISO)	D		W Wrench Flat		Wa Hex. Flat	N		E		E1		L		M		I	O-ring**
	mm	inch	inch	mm	mm	inch	mm	inch	mm	mm	mm	mm	mm	mm	mm	mm	mm	mm	mm	Dash No.
771LG SS 6 X 1/8 POS.	6		G-1/8-28	4.0		1/2	12.7	9/16	19.6		27.0		26.4		8.1		17.3		15.3	***
771LG SS 6 X 1/4 POS.	6		G-1/4-19	4.8		5/8	15.9	3/4	21.6		29.0		32.2		9.1		22.9		15.3	-111
771LG SS 8 X 1/4 POS.	8		G-1/4-19	5.9		5/8	15.9	3/4	22.4		29.9		32.2		9.1		22.9		16.2	-111
771LG SS 10 X 1/4 POS.	10		G-1/4-19	5.9		15/16	23.8	3/4	25.9		33.5		35.0		9.1		22.9		17.2	-111

#### TUBE (INCH) TO ISO PARALLEL THREAD (POSITIONABLE)\*

Ordering Information	A Tube O.D.		T (ISO)	D		W Wrench Flat		Wa Hex. Flat	N		E		E1		L		M		I	O-ring**	
	inch	mm	inch	inch	mm	inch	mm	inch	inch	mm	inch	mm	inch	mm	inch	mm	inch	mm	inch	mm	Dash No.
771LG SS 1/4 X 1/8 POS.	1/4	6.35	G-1/8-28	.16	4.0	1/2	12.7	9/16	.77	19.6	1.06	26.9	1.04	26.4	.32	8.1	.68	17.3	.60	15.2	***
771LG SS 1/4 X 1/4 POS.	1/4	6.35	G-1/4-19	.19	4.8	5/8	15.9	3/4	.85	21.6	1.14	28.9	1.27	32.2	.36	9.1	.90	22.9	.60	15.2	-111
771LG SS 3/8 X 1/4 POS.	3/8	9.52	G-1/4-19	.23	5.9	5/8	15.9	3/4	.91	23.1	1.20	30.5	1.27	32.2	.36	9.1	.90	22.9	.66	16.8	-111

#### Reference Specifications:

DIN - ISO 228/1  
BS - 2779  
JIS - B0202  
ISO - 228/1-BSP-P

\*\*Standard O-rings materials are Fluorocarbon FKM 90 Durometer. Other O-ring materials available upon request.

\*\*\*Not standard O-ring size.

"D" - Dimension is minimum opening. Dimensions are for reference only and are subject to change without notice.



# 771 LF FEMALE RUN TEE

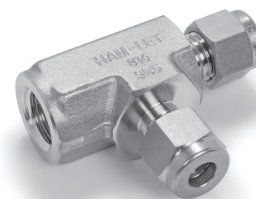
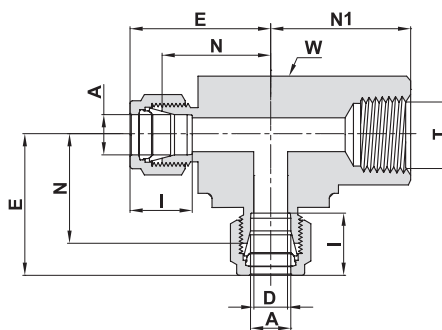

## TUBE (METRIC) TO FEMALE NPT THREAD

Ordering Information	A		T (NPT)	D	W Wrench Flat		N	E		N1	I
	mm	inch			mm	inch		mm	mm		
771LF_ 6 X 1/8	6	1/8	1/8	4.8	5/8	15.9	19.6	27.0	19.0	15.3	
771LF_ 6 X 1/4	6	1/4	1/4	4.8	13/16	20.6	22.4	29.8	22.4	15.3	
771LF_ 8 X 1/8	8	1/8	1/8	6.4	5/8	15.9	22.4	29.9	22.4	16.2	
771LF_ 8 X 1/4	8	1/4	1/4	6.4	13/16	20.6	23.1	30.6	22.4	16.2	
771LF_ 10 X 1/4	10	1/4	1/4	7.9	13/16	20.6	25.9	33.5	22.4	17.2	
771LF_ 12 X 1/4	12	1/4	1/4	9.5	13/16	20.6	25.9	36.0	22.4	22.8	
771LF_ 12 X 3/8	12	3/8	3/8	9.5	15/16	23.8	25.9	36.0	22.4	22.8	
771LF_ 12 X 1/2	12	1/2	1/2	9.5	1 1/16	27.0	29.7	39.8	28.4	22.8	
771LF_ 16 X 1/2	16	1/2	1/2	12.7	1 1/16	27.0	29.7	39.8	28.4	24.4	

## TUBE (INCH) TO FEMALE NPT THREAD

Ordering Information	A Tube O.D.		T (NPT)	D		W Wrench Flat		N		E		N1		I	
	inch	mm		inch	mm	inch	mm	inch	mm	inch	mm	inch	mm	inch	mm
771LF_ 1/8 X 1/8	1/8	3.17	1/8	.09	2.28	5/8	15.9	.71	18.00	.97	24.63	.75	19.05	.50	12.7
771LF_ 1/4 X 1/8	1/4	6.35	1/8	.19	4.82	5/8	15.9	.77	19.55	1.06	26.92	.75	19.05	.60	15.2
771LF_ 1/4 X 1/4	1/4	6.35	1/4	.19	4.82	13/16	20.6	.88	22.35	1.17	29.71	.88	22.35	.60	15.2
771LF_ 3/8 X 1/4	3/8	9.52	1/4	.28	7.11	13/16	20.6	.94	23.87	1.23	31.24	.88	22.35	.66	16.8
771LF_ 1/2 X 3/8	1/2	12.70	3/8	.41	10.41	15/16	23.8	1.02	25.9	1.42	36.07	.88	22.35	.90	22.9
771LF_ 1/2 X 1/2	1/2	12.70	1/2	.41	10.41	1 1/16	27.0	1.17	29.72	1.57	39.88	1.12	28.45	.90	22.9
771LF_ 3/4 X 3/4	3/4	19.05	3/4	.62	15.75	1 3/8	34.9	1.36	34.54	1.76	44.70	1.25	31.75	.96	24.4
771LF_ 1 X 3/4	1	25.4	3/4	.88	22.35	1 3/8	34.9	1.45	36.83	1.93	49.02	1.25	31.75	1.23	31.2
771LF_ 1 X 1	1	25.4	1	.88	22.35	1 11/16	42.9	1.63	41.40	2.11	53.59	1.50	38.10	1.23	31.2

"D" - Dimension is minimum opening. Dimensions are for reference only and subject to change without notice.

## 772 L MALE BRANCH TEE

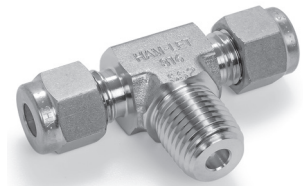
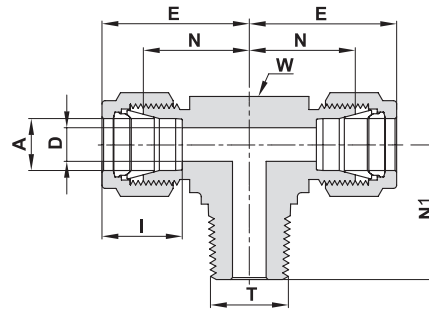

### TUBE (METRIC) TO MALE NPT THREAD

Ordering Information	A Tube O.D.		T (NPT)	D		W Wrench Flat		N		E		N1		I
	mm	mm	inch	mm	mm	inch	mm	mm	mm	mm	mm	mm	mm	
772L_6 X 1/8	6	6	1/8	4.8	4.8	1/2	12.7	19.6	19.6	27.0	27.0	18.8	18.8	15.3
772L_6 X 1/4	6	6	1/4	4.8	4.8	1/2	12.7	19.6	19.6	27.0	27.0	23.4	23.4	15.3
772L_8 X 1/8	8	8	1/8	4.8	4.8	5/8	15.9	22.4	22.4	29.9	29.9	20.8	20.8	16.2
772L_8 X 1/4	8	8	1/4	6.4	6.4	5/8	15.9	22.4	22.4	29.9	29.9	25.4	25.4	16.2
772L_10 X 1/4	10	10	1/4	7.1	7.1	13/16	20.6	25.9	25.9	33.5	33.5	28.2	28.2	17.2
772L_12 X 1/4	12	12	1/4	7.1	7.1	13/16	20.6	25.9	25.9	36.0	36.0	28.2	28.2	22.8
772L_12 X 3/8	12	12	3/8	9.5	9.5	13/16	20.6	25.9	25.9	36.0	36.0	28.2	28.2	22.8
772L_12 X 1/2	12	12	1/2	9.5	9.5	13/16	20.6	25.9	25.9	36.0	36.0	33.0	33.0	22.8
772L_16 X 1/2	16	16	1/2	11.9	11.9	15/16	23.8	28.7	28.7	38.8	38.8	35.8	35.8	24.4

### TUBE (INCH) TO MALE NPT THREAD

Ordering Information	A Tube O.D.		T (NPT)	D		W Wrench Flat		N		E		N1		I	
	inch	mm	inch	inch	mm	inch	mm	inch	mm	inch	mm	inch	mm	inch	mm
772L_1/8 X 1/8	1/8	3.17	1/8	.09	2.28	7/16	11.1	.67	17.02	.93	23.62	.70	17.78	.50	12.7
772L_1/8 X 1/4	1/8	3.17	1/4	.09	2.28	1/2	12.7	.71	18.03	.97	24.64	.92	23.37	.50	12.7
772L_3/16 X 1/8	3/16	4.76	1/8	.12	3.04	7/16	11.1	.70	17.78	.96	24.38	.70	17.78	.54	13.7
772L_1/4 X 1/8	1/4	6.35	1/8	.19	4.82	1/2	12.7	.77	19.56	1.06	26.92	.74	18.80	.60	15.2
772L_1/4 X 1/4	1/4	6.35	1/4	.19	4.82	1/2	12.7	.77	19.56	1.06	26.92	.92	23.37	.60	15.2
772L_5/16 X 1/8	5/16	7.93	1/8	.19	4.82	5/8	15.9	.88	22.35	1.17	29.71	.82	20.83	.64	16.2
772L_3/8 X 1/4	3/8	9.52	1/4	.28	7.11	5/8	15.9	.91	23.11	1.20	30.48	1.00	25.40	.66	16.8
772L_3/8 X 3/8	3/8	9.52	3/8	.28	7.11	13/16	20.6	1.02	25.91	1.31	33.27	1.11	28.19	.66	16.8
772L_1/2 X 3/8	1/2	12.70	3/8	.38	9.65	13/16	20.6	1.02	25.91	1.42	36.07	1.11	28.19	.90	22.9
772L_1/2 X 1/2	1/2	12.70	1/2	.41	10.41	13/16	20.6	1.02	25.91	1.42	36.07	1.30	33.02	.90	22.9
772L_5/8 X 1/2	5/8	15.87	1/2	.47	11.94	15/16	23.8	1.13	28.7	1.53	38.86	1.41	35.81	.96	24.4
772L_3/4 X 3/4	3/4	19.05	3/4	.62	15.75	1 1/16	27.0	1.17	29.72	1.57	39.88	1.45	36.83	.96	24.4

"D" - Dimension is minimum opening. Dimensions are for reference only and subject to change without notice.

# 772 LOB MALE BRANCH TEE POS

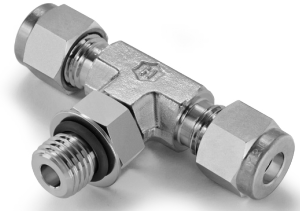
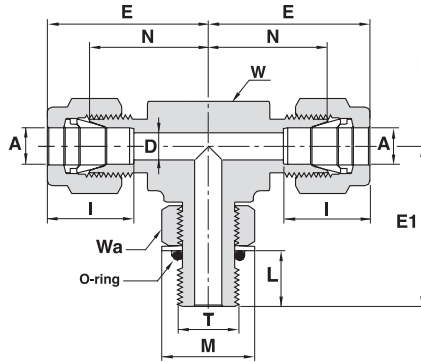

TUBE TO SAE/MS STRAIGHT THREAD BOSS (POSITIONABLE)\*

Ordering Information	A Tube O.D.		T SAE/MS	D		W Wrench Flat		Wa Hex. Flat	N		E		E1		L		M		I	O-ring**	
	inch	mm	inch	inch	mm	inch	mm	inch	inch	mm	inch	mm	inch	mm	inch	mm	inch	mm	inch	mm	Dash No.
772LOB SS 1/4 X 7/16-20 POS.	1/4	6.35	7/16-20	.19	4.8	1/2	12.7	9/16	.83	21.10	1.12	28.45	1.12	28.45	.39	9.9	.65	16.5	.60	15.2	-904
772LOB SS 3/8 X 9/16-18 POS.	3/8	9.52	9/16-18	.28	7.1	5/8	15.9	11/16	.97	24.64	1.26	32.00	1.27	32.26	.44	11.2	.79	20.1	.66	16.8	-906

\*Per SAE J1926 and MS 16142. See page 53 for mounting dimensions.

\*\*Standard O-rings materials are Fluorocarbon FKM 90 Durometer. Other O-ring materials available upon request.

"D" - Dimension is minimum opening. Dimensions are for reference only and subject to change without notice.

**POSITIONABLES**  
ISO PARALLEL THREAD

**772 LG**  
**MALE BRANCH**  
**TEE POS**

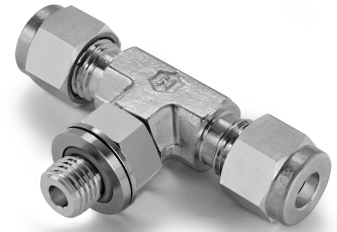
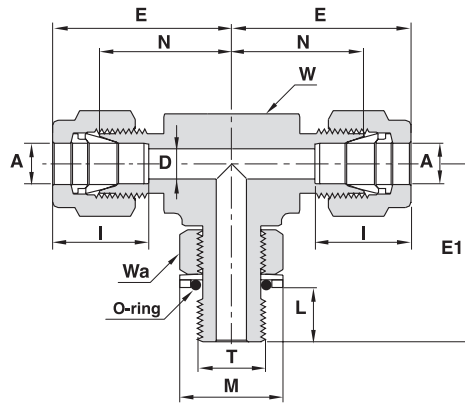

**TUBE (METRIC) TO ISO PARALLEL THREAD (POSITIONABLE)\***

Ordering Information	A Tube O.D.		T (ISO)		D		W Wrench Flat		Wa Hex. Flat		N		E		E1		L		M		I		O-ring**
	mm	inch	mm	inch	mm	inch	mm	inch	mm	inch	mm	inch	mm	inch	mm	inch	mm	inch	mm	inch	mm	inch	Dash No.
772LG SS 6 X 1/8 POS.	6		G-1/8-28		4.0		1/2	12.7	9/16		19.6		27.0		26.4		8.1		17.3		15.3		***
772LG SS 6 X 1/4 POS.	6		G-1/4-19		4.8		5/8	15.9	3/4		21.6		29.0		32.2		9.1		22.9		15.3		-111
772LG SS 8 X 1/4 POS.	8		G-1/4-19		5.9		5/8	15.9	3/4		22.4		29.9		32.2		9.1		22.9		16.2		-111
772LG SS 10 X 1/4 POS.	10		G-1/4-19		5.9		15/16	23.8	3/4		25.9		33.5		35.0		9.1		22.9		17.2		-111

**TUBE (INCH) TO ISO PARALLEL THREAD (POSITIONABLE)\***

Ordering Information	A Tube O.D.		T (ISO)		D		W Wrench Flat		Wa Hex. Flat		N		E		E1		L		M		I		O-ring**
	inch	mm	inch	mm	inch	mm	inch	mm	inch	mm	inch	mm	inch	mm	inch	mm	inch	mm	inch	mm	inch	mm	Dash No.
772LG SS 1/4 X 1/8 POS.	1/4	6.35	G-1/8-28	0.16	4.0	1/2	12.7	9/16	0.77	19.6	1.06	26.9	1.04	26.4	0.32	8.1	0.68	17.3	0.60	15.2			***
772LG SS 1/4 X 1/4 POS.	1/4	6.35	G-1/4-19	0.19	4.8	5/8	15.9	3/4	0.85	21.6	1.14	28.9	1.27	32.2	0.36	9.1	0.90	22.9	0.60	15.2			-111
772LG SS 3/8 X 1/4 POS.	3/8	9.52	G-1/4-19	0.23	5.9	5/8	15.9	3/4	0.91	23.1	1.20	30.5	1.27	32.2	0.36	9.1	0.90	22.9	0.66	16.8			-111

**Reference Specifications:**

DIN - ISO 228/1      \*\*Standard O-rings materials are Fluorocarbon FKM 90 Durometer. Other O-ring materials are available upon request.  
 BS - 2779            \*\*\*Not standard O-ring size.  
 JIS - B0202  
 ISO - 228/1-BSP-P      "D" - Dimension is minimum opening. Dimensions are for reference only and subject to change without notice.

## 772 LF FEMALE BRANCH TEE

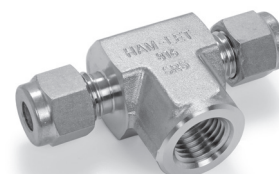
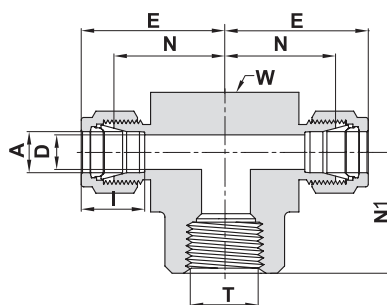

### TUBE (METRIC) TO FEMALE NPT THREAD

Ordering Information	A Tube O.D.		T (NPT)	D		W Wrench Flat		N		E		N1		I	
	mm	mm	inch	mm	mm	inch	mm	mm	mm	mm	mm	mm	mm	mm	mm
772LF _ 6 X 1/8	6	6	1/8	4.8	4.8	5/8	15.9	19.6	19.6	27.0	19.0	15.3	15.3	15.3	15.3
772LF _ 6 X 1/4	6	6	1/4	4.8	4.8	13/16	20.6	22.4	22.4	29.8	22.4	15.3	15.3	15.3	15.3
772LF _ 8 X 1/8	8	8	1/8	6.4	6.4	5/8	15.9	22.4	22.4	29.9	19.0	16.2	16.2	16.2	16.2
772LF _ 8 X 1/4	8	8	1/4	6.4	6.4	13/16	20.6	23.1	23.1	30.6	22.4	16.2	16.2	16.2	16.2
772LF _ 10 X 1/4	10	10	1/4	7.9	7.9	13/16	20.6	25.9	25.9	33.5	22.4	17.2	17.2	17.2	17.2
772LF _ 10 X 3/8	10	10	3/8	7.9	7.9	15/16	23.8	25.9	25.9	33.5	22.4	17.2	17.2	17.2	17.2
772LF _ 12 X 1/4	12	12	1/4	9.5	9.5	13/16	20.6	25.9	25.9	36.0	22.4	22.8	22.8	22.8	22.8
772LF _ 12 X 3/8	12	12	3/8	9.5	9.5	15/16	23.8	25.9	25.9	36.0	22.4	22.8	22.8	22.8	22.8
772LF _ 12 X 1/2	12	12	1/2	9.5	9.5	1 1/16	27.0	28.7	28.7	38.8	28.4	22.8	22.8	22.8	22.8
772LF _ 16 X 1/2	16	16	1/2	12.7	12.7	1 1/16	27.0	28.7	28.7	38.8	28.4	24.4	24.4	24.4	24.4

### TUBE (INCH) TO FEMALE NPT THREAD

Ordering Information	A Tube O.D.		T (NPT)	D		W Wrench Flat		N		E		N1		I	
	inch	mm	inch	inch	mm	inch	mm	inch	mm	inch	mm	inch	mm	inch	mm
772LF _ 1/8 X 1/8	1/8	3.17	1/8	.09	2.28	5/8	15.9	.70	18.00	.97	24.64	.75	19.05	.50	12.7
772LF _ 1/4 X 1/8	1/4	6.35	1/8	.19	4.82	5/8	15.9	.77	19.56	1.06	26.96	.75	19.05	.60	15.2
772LF _ 1/4 X 1/4	1/4	6.35	1/4	.19	4.82	13/16	20.6	.88	22.35	1.17	29.71	.88	22.35	.60	15.2
772LF _ 3/8 X 1/4	3/8	9.52	1/4	.28	7.11	13/16	20.6	.94	23.88	1.23	31.24	.88	22.35	.66	16.8
772LF _ 3/8 X 3/8	3/8	9.52	3/8	.28	7.11	15/16	23.8	1.02	25.90	1.31	33.27	.88	22.35	.66	16.8
772LF _ 3/8 X 1/2	3/8	9.52	1/2	.28	7.11	1 1/16	27.0	1.13	28.70	1.42	36.07	1.12	28.45	.66	16.8
772LF _ 1/2 X 1/4	1/2	12.70	1/4	.41	10.41	13/16	20.6	1.02	25.90	1.42	36.07	.88	22.35	.90	22.9
772LF _ 1/2 X 3/8	1/2	12.70	3/8	.41	10.41	15/16	23.8	1.02	25.90	1.42	36.07	.88	22.35	.90	22.9
772LF _ 1/2 X 1/2	1/2	12.70	1/2	.41	10.41	1 1/16	27.0	1.13	28.70	1.53	38.86	1.12	28.45	.90	22.9
772LF _ 5/8 X 1/2	5/8	15.87	1/2	.50	12.70	1 1/16	27.0	1.13	28.70	1.53	38.86	1.12	28.44	.96	24.4
772LF _ 3/4 X 3/4	3/4	19.05	3/4	.62	15.74	1 3/8	34.9	1.36	34.50	1.76	44.70	1.25	31.75	.96	24.4
772LF _ 1 X 3/4	1	25.4	3/4	.88	22.35	1 3/8	34.9	1.45	36.83	1.93	49.02	1.25	31.75	1.23	31.2
772LF _ 1 X 1	1	25.4	1	.88	22.35	1 11/16	42.9	1.63	41.40	2.11	53.60	1.50	38.10	1.23	31.2

"D" - Dimension is minimum opening. Dimensions are for reference only and subject to change without notice.

# 774 L BULKHEAD UNION

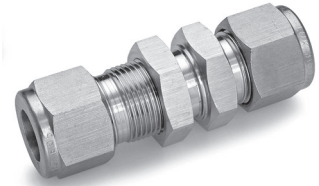
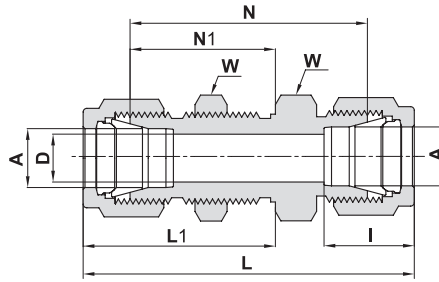

## TUBE (METRIC) TO TUBE (METRIC)

Ordering Information	A Tube O.D.		D		W Hex. Flat	N		N1		L		L1		I		Panel Hole Drill Size	Max. Panel Thickness
	mm	mm	mm	mm	mm	mm	mm	mm	mm	mm	mm	mm	mm	mm	mm	mm	mm
774L_3	3		2.4		14	38.1		24.6		51.3		31.2		12.9		8.30	12.7
774L_4	4		2.4		14	40.4		25.4		53.6		32.0		13.7		9.90	12.7
774L_6	6		4.8		16	42.9		26.2		57.7		33.6		15.3		11.50	10.2
774L_8	8		6.4		18	46.0		28.6		61.0		36.1		16.2		13.10	11.2
774L_10	10		7.9		22	48.5		29.4		63.7		37.0		17.2		16.25	11.2
774L_12	12		9.5		24	50.8		31.8		71.0		41.9		22.8		19.50	12.7
774L_14	14		11.0		27	52.3		32.5		72.5		42.6		24.4		22.80	12.7
774L_15	15		11.9		27	52.3		32.5		72.5		42.6		24.4		22.80	12.7
774L_16	16		12.7		27	52.3		32.5		72.5		42.6		24.4		22.80	12.7
774L_18	18		15.1		30	58.7		37.3		78.9		47.4		24.4		26.00	16.8
774L_20	20		15.9		35	64.3		42.9		84.5		53.0		26.0		29.00	19.0
774L_25	25		21.8		41	71.4		45.2		96.0		57.5		31.3		33.70	19.0
774L_30	30*		26.2		50	80.5		48.6		123.7		70.2		39.6		40.5	19
774L_32	32*		28.6		50	82.3		49.5		128.3		72.5		42		42.5	19
774L_38	38*		33.7		60	89.8		51.9		145.0		79.5		49.4		50.50	19.0

## TUBE (INCH) TO TUBE (INCH)

Ordering Information	A Tube O.D.		D		W Hex. Flat	N		N1		L		L1		I		Panel Hole Drill Size	Max. Panel Thickness		
	inch	mm	inch	mm	inch	inch	mm	inch	mm	inch	mm	inch	mm	inch	mm	inch	mm		
774L_1/16	1/16	1.58	.05	1.27	5/16	.94	23.88	.53	13.46	1.24	31.5	.68	17.3	.34	8.6	13/64	5.16	.12	3.05
774L_1/8	1/8	3.17	.09	2.28	1/2	1.50	38.10	.97	24.63	2.02	51.30	1.23	31.24	.50	12.7	21/64	8.33	.50	12.70
774L_3/16	3/16	4.76	.12	3.04	9/16	1.59	40.38	1.00	25.40	2.11	53.59	1.26	32.00	.54	13.7	25/64	9.92	.50	12.70
774L_1/4	1/4	6.35	.19	4.82	5/8	1.69	42.92	1.03	26.16	2.27	57.65	1.32	33.52	.60	15.2	29/64	11.50	.40	10.16
774L_5/16	5/16	7.93	.25	6.35	11/16	1.81	45.97	1.12	28.44	2.39	60.70	1.41	35.81	.64	16.2	33/64	13.09	.44	11.17
774L_3/8	3/8	9.52	.28	7.11	3/4	1.87	47.5	1.16	29.46	2.45	62.2	1.45	36.83	.66	16.8	37/64	14.68	.44	11.17
774L_1/2	1/2	12.70	.41	10.41	15/16	2.00	50.80	1.25	31.75	2.80	71.12	1.65	41.91	.90	22.9	49/64	19.44	.50	12.70
774L_5/8	5/8	15.87	.50	12.70	1 1/16	2.06	52.32	1.28	32.51	2.86	72.64	1.68	42.67	.96	24.4	57/64	22.62	.50	12.70
774L_3/4	3/4	19.05	.62	15.75	1 3/16	2.31	58.67	1.47	37.33	3.11	78.99	1.87	47.49	.96	24.4	1 1/64	25.79	.66	16.76
774L_1	1	25.40	.88	22.35	1 5/8	2.81	71.37	1.78	45.21	3.77	95.76	2.26	57.40	1.23	31.2	1 21/64	33.73	.75	19.05
774L_1 1/4	1 1/4*	31.75	1.09	27.70	1 7/8	3.11	79.00	1.88	47.75	4.85	123.19	2.75	69.85	1.62	41.2	1 41/64	41.67	.75	19.05
774L_1 1/2	1 1/2*	38.10	1.34	34.00	2 1/4	3.34	84.80	1.94	49.28	5.48	139.19	3.01	76.45	1.97	50.0	1 61/64	49.61	.75	19.05
774L_2	2*	50.80	1.81	45.97	2 3/4	4.16	105.66	2.22	56.39	7.10	180.34	3.69	93.73	2.66	67.6	2 41/64	67.07	.75	19.05

\*Including low friction paste (see page 101)

"D" - Dimension is minimum opening. Dimensions are for reference only and subject to change without notice.

## 774 LF BULKHEAD FEMALE CONNECTOR

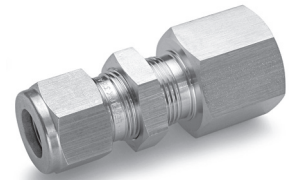
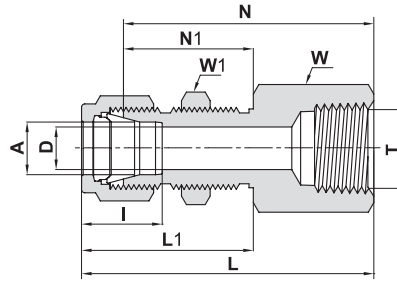

### TUBE (METRIC) TO FEMALE NPT THREAD

Ordering Information	A Tube O.D.		T (NPT)	D		W Hex. Flat	W1 Hex. Flat	N		N1		L		L1		I	Panel Hole Drill Size		Max. Panel Thickness	
	mm	inch	inch	mm	mm	mm	mm	mm	mm	mm	mm	mm	mm	mm	mm	mm	mm	mm	mm	
774LF_6 X 1/4	6	1/4	1/4	4.8	19	16	44.4	26.2	51.8	33.6	15.3	11.5	10.2							
774LF_12 X 1/2	12	1/2	1/2	9.5	27	24	56.4	31.8	66.5	41.9	22.8	19.5	12.7							

### TUBE (INCH) TO FEMALE NPT THREAD

Ordering Information	A Tube O.D.		T (NPT)	D		W Hex. Flat	W1 Hex. Flat	N		N1		L		L1		I	Panel Hole Drill Size		Max. Panel Thickness		
	inch	mm	inch	inch	mm	inch	inch	inch	mm	inch	mm	inch	mm	inch	mm	inch	mm	inch	mm		
774LF_1/8X1/8	1/8	3.17	1/8	.09	2.28	9/16	1/2	1.50	38.10	.97	24.63	1.76	44.70	1.23	31.24	.50	12.7	21/64	8.33	.50	12.70
774LF_1/4X1/8	1/4	6.35	1/8	.19	4.82	5/8	5/8	1.56	39.62	1.03	26.16	1.85	46.99	1.32	33.52	.60	15.2	29/64	11.50	.40	10.16
774LF_1/4X1/4	1/4	6.35	1/4	.19	4.82	3/4	5/8	1.75	44.45	1.03	26.16	2.04	51.81	1.32	33.52	.60	15.2	29/64	11.50	.40	10.16
774LF_3/8X1/4	3/8	9.52	1/4	.28	7.11	3/4	3/4	1.88	47.75	1.16	29.46	2.17	55.11	1.45	36.83	.66	16.8	37/64	14.68	.44	11.17
774LF_1/2X3/8	1/2	12.70	3/8	.41	10.41	15/16	15/16	2.03	51.56	1.25	31.75	2.43	61.72	1.65	41.91	.90	22.9	49/64	19.44	.50	12.70
774LF_1/2X1/2	1/2	12.70	1/2	.41	10.41	1 1/16	15/16	2.22	56.38	1.25	31.75	2.62	66.54	1.65	41.91	.90	22.9	49/64	19.44	.50	12.70

## 774 LT BULKHEAD REDUCER

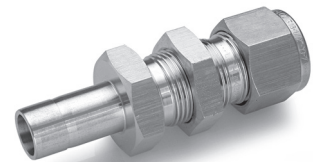
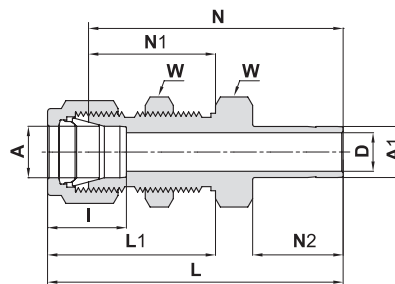

### TUBE (INCH) TO TUBE (INCH)

Ordering Information	A Tube O.D.		A1 Tube O.D.	D		W Hex. Flat	N		N1		N2		L		L1		I	Panel Hole Drill Size		Max. Panel Thickness		
	inch	mm	inch	inch	mm	inch	inch	mm	inch	mm	inch	mm	inch	mm	inch	mm	inch	mm	inch	mm		
774LT_1/8X1/8	1/8	3.17	1/8	.08	2.03	1/2	1.69	42.92	.97	24.63	.53	13.46	1.95	49.53	1.23	31.24	.50	12.7	21/64	8.33	.50	12.70
774LT_1/4X1/4	1/4	6.35	1/4	.17	4.20	5/8	1.91	48.50	1.03	26.16	.62	15.74	2.20	55.88	1.32	33.52	.60	15.2	29/64	11.50	.40	10.16
774LT_3/8X3/8	3/8	9.52	3/8	.28	7.11	3/4	2.12	53.85	1.16	29.46	.69	17.52	2.41	61.21	1.45	36.83	.66	16.8	37/64	14.68	.44	11.17
774LT_1/2X1/2	1/2	12.7	1/2	.39	9.90	15/16	2.47	62.73	1.25	31.75	.91	23.11	2.87	72.89	1.65	41.91	.90	22.9	49/64	19.44	.50	12.70
774LT_5/8X5/8	5/8	15.87	5/8	.50	12.70	1 1/16	2.56	65.02	1.28	32.51	.97	24.64	2.96	75.18	1.68	42.67	.96	24.4	57/64	22.62	.50	12.70
774LT_3/4X3/4	3/4	19.05	3/4	.59	15.00	1 3/16	2.81	71.37	1.47	37.33	.97	24.64	3.21	81.53	1.87	47.49	.96	24.4	1 1/64	25.79	.66	16.76
774LT_1X1	1	25.40	1	.80	20.30	1 5/8	3.47	88.14	1.78	45.21	1.30	33.02	3.95	100.33	2.26	57.40	1.23	31.2	1 21/64	33.73	.75	19.05

"D" - Dimension is minimum opening. Dimensions are for reference only and subject to change without notice.



# 774 LM BULKHEAD MALE CONNECTOR

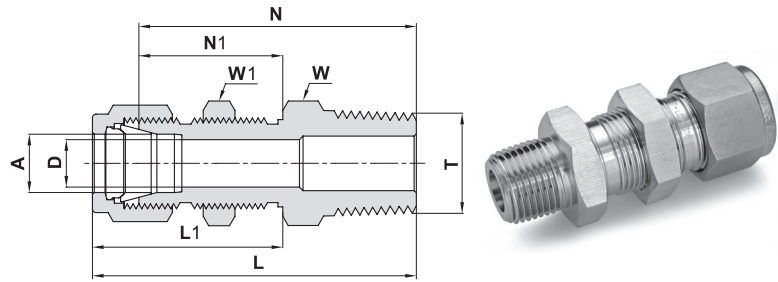

## TUBE (METRIC) TO MALE NPT THREAD

Ordering Information	A Tube O.D.		T (NPT)	D	W Hex. Flat	W1 Hex. Flat	N	N1	L	L1	Panel Hole Drill Size	Max. Panel Thickness
	mm	inch	inch	mm	mm	mm	mm	mm	mm	mm	mm	mm
774LM _ 6 X 1/8	6	1/8	1/8	4.8	16	16	42.2	26.2	49.6	33.6	11.5	10.2
774LM _ 6 X 1/4	6	1/4	1/4	4.8	16	16	46.2	26.2	53.6	33.6	11.5	10.2
774LM _ 12 X 1/2	12	1/2	1/2	9.5	24	24	58.7	31.8	68.8	41.9	19.5	12.7

## TUBE (INCH) TO MALE NPT THREAD

Ordering Information	A Tube O.D.		T (NPT)	D		W Hex. Flat	W1 Hex. Flat	N		N1		L		L1		Panel Hole Drill Size		Max. Panel Thickness	
	inch	mm	inch	inch	mm	inch	inch	inch	mm	inch	mm	inch	mm	inch	mm	inch	mm	inch	mm
774LM _ 1/8 X 1/8	1/8	3.17	1/8	.09	2.28	1/2	1/2	1.57	39.90	.97	24.60	1.83	46.48	1.23	31.24	21/64	8.33	.50	12.70
774LM _ 1/4 X 1/8	1/4	6.35	1/8	.19	4.82	5/8	5/8	1.66	42.20	1.03	26.20	1.95	49.53	1.32	33.52	29/64	11.50	.40	10.16
774LM _ 1/4 X 1/4	1/4	6.35	1/4	.19	4.82	5/8	5/8	1.84	46.70	1.03	26.16	2.13	54.10	1.32	33.52	29/64	11.50	.40	10.16
774LM _ 3/8 X 1/4	3/8	9.52	1/4	.28	7.11	3/4	3/4	1.97	50.00	1.16	29.46	2.26	57.40	1.45	36.83	37/64	14.68	.44	11.17
774LM _ 3/8 X 3/8	3/8	9.52	3/8	.28	7.11	3/4	3/4	1.97	50.04	1.16	29.46	2.26	57.40	1.45	36.83	37/64	14.68	.44	11.17
774LM _ 3/8 X 1/2	3/8	9.52	1/2	.28	7.11	7/8	3/4	2.22	56.39	1.16	29.46	2.51	63.75	1.45	36.83	37/64	14.68	.44	11.17
774LM _ 1/2 X 3/8	1/2	12.70	3/8	.40	10.40	15/16	15/16	2.09	53.10	1.25	31.75	2.49	83.25	1.65	41.91	49/64	19.44	.50	12.70
774LM _ 1/2 X 1/2	1/2	12.70	1/2	.40	10.40	15/16	15/16	2.31	58.70	1.25	31.70	2.71	68.83	1.65	41.91	49/64	19.44	.50	12.70
774LM _ 3/4 X 3/4	3/4	19.05	3/4	.62	15.74	1 3/16	1 3/16	2.60	66.04	1.47	37.33	3.00	76.20	1.87	47.49	1 1/64	25.79	.66	16.76
774LM _ 1 X 1	1	25.4	1	.88	22.35	1 5/8	1 5/8	3.19	81.02	1.78	45.21	3.67	93.21	2.26	57.40	1 21/64	33.73	.75	19.05

# 775 L BULKHEAD REDUCING UNION

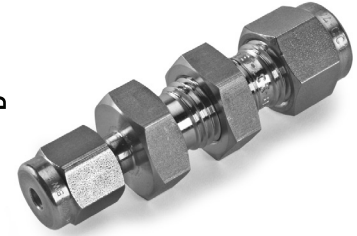
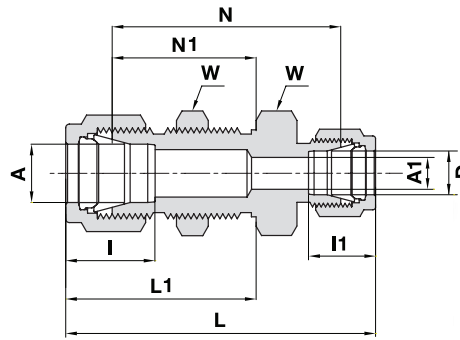

## TUBE (METRIC) TO TUBE (INCH)

Ordering Information	A Tube O.D.		A1 Tube O.D.		D		W Hex. Flat		N		N1		L		L1		I		I1		Panel Hole Drill Size		Max. Panel Thickness	
	mm	inch	mm	inch	mm	mm	mm	mm	mm	mm	mm	mm	mm	mm	mm	mm	mm	mm	mm	mm	mm	mm	mm	
775L_ 6 X 1/8	6	1/8	2.4	16	41.1	26.2	55.1	33.6	15.3	12.7	11.5	10.2												
775L_ 6 X 1/4	6	1/4	4.8	16	42.9	26.2	57.7	33.6	15.3	15.2	11.5	10.2												
775L_ 12 X 1/2	12	1/2	9.5	24	50.8	31.8	71.1	41.9	22.8	22.9	19.5	12.7												
775L_ 18 X 3/4	18	3/4	15.1	30	58.7	37.3	79.0	47.4	24.4	24.4	26.0	16.8												

## TUBE (INCH) TO TUBE (INCH)

Ordering Information	A Tube O.D.		A1 Tube O.D.		D		W Hex. Flat		N		N1		L		L1		I		I1		Panel Hole Drill Size		Max. Panel Thickness	
	inch	mm	inch	mm	inch	mm	inch	mm	inch	mm	inch	mm	inch	mm	inch	mm	inch	mm	inch	mm	inch	mm	inch	mm
775L_ 1/8 X 1/16	1/8	3.17	1/16	1.58	.05	1.27	1/2	1.44	36.57	.97	24.64	1.85	46.99	1.23	31.24	.50	12.7	.34	8.6	21/64	8.33	.50	12.70	
775L_ 3/16 X 1/4	3/16	4.76	1/4	6.35	.12	3.04	9/16	1.62	41.15	1.00	25.40	2.17	55.12	1.26	32.00	.54	13.7	.60	15.2	25/64	9.92	.50	12.70	
775L_ 1/4 X 1/8	1/4	6.35	1/8	3.17	.09	2.28	5/8	1.62	41.15	1.03	26.16	2.17	55.12	1.32	33.53	.60	15.2	.50	12.7	29/64	11.50	.40	10.16	
775L_ 1/4 X 3/8	1/4	6.35	3/8	9.52	.19	4.82	5/8	1.74	44.20	1.03	26.16	2.61	66.29	1.32	33.53	.60	15.2	.66	16.8	29/64	11.50	.40	10.16	
775L_ 3/8 X 1/4	3/8	9.52	1/4	6.35	.19	4.82	3/4	1.81	45.97	1.16	29.46	2.39	60.71	1.45	36.83	.66	16.8	.60	15.2	37/64	14.68	.44	11.17	
775L_ 1/2 X 1/4	1/2	12.70	1/4	6.35	.19	4.82	15/16	1.94	49.28	1.25	31.75	2.63	66.80	1.65	41.91	.90	22.9	.60	15.2	49/64	19.44	.50	12.70	
775L_ 1/2 X 5/8	1/2	12.70	5/8	15.87	.41	10.41	15/16	2.03	51.56	1.25	31.75	2.83	71.88	1.65	41.91	.90	22.9	.96	24.4	49/64	19.44	.50	12.70	
775L_ 5/8 X 3/8	5/8	15.87	3/8	9.52	.28	7.11	1 1/16	2.06	52.32	1.28	32.51	2.75	69.85	1.68	42.67	.96	24.4	.66	16.8	57/64	22.62	.50	12.70	

**774 LSS**  
**BULKHEAD RETAINER**

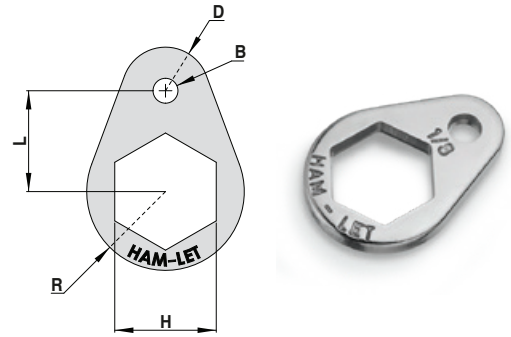

Ordering Information	Fitting Size		H	L	R	D	B	Drill Hole Size	Drill Screw Size
	inch	mm	inch	inch	inch	inch	inch	inch	mm
RETAINER FOR 774L SS 1/8	1/8	-	1/2	1/2	13/32	7/32	5/32	0.12	3.5
RETAINER FOR 774L SS 1/4-6	1/4	6	5/8	5/8	1/2	9/32	5/32	0.12	3.5
RETAINER FOR 774L SS 3/8	3/8	-	3/4	3/4	5/8	11/32	5/32	0.12	3.5

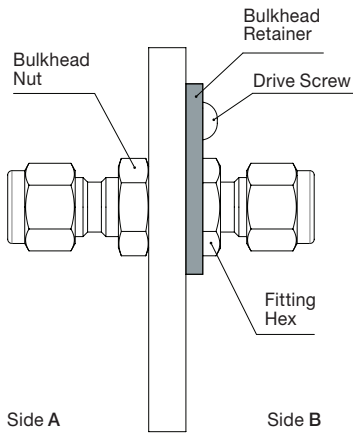

Using Bulkhead Retainer installation can easily be performed by a single installer. The bulkhead retainer holds the fixed body hex stationary, allowing the installer to tighten only the bulkhead lock nut.

# 7102 L UNION CROSS

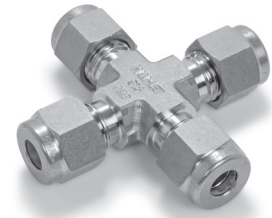
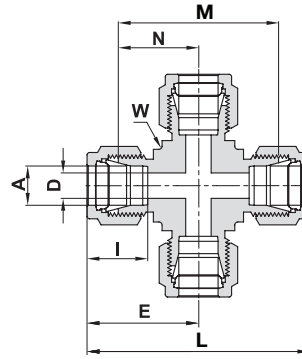

## ALL TUBES (METRIC)

Ordering Information	A Tube O.D.		D		W Wrench Flat		N		E		M		L		I	
	mm	mm	mm	mm	inch	mm	mm	mm	mm	mm	mm	mm	mm	mm	mm	mm
7102L_3	3		2.4		3/8	9.5	15.7		22.3		31.5		44.7		12.9	
7102L_6	6		4.8		1/2	12.7	19.6		27.0		39.1		53.9		15.3	
7102L_8	8		6.4		5/8	15.9	22.4		29.9		44.7		59.7		16.2	
7102L_10	10		7.9		13/16	20.6	25.9		33.5		51.8		67.0		17.2	
7102L_12	12		9.5		13/16	20.6	25.9		36.0		51.8		72.0		22.8	
7102L_16	16		12.7		15/16	23.8	26.9		37.0		53.8		74.0		24.4	
7102L_18	18		15.1		1 1/16	27.0	28.2		38.3		56.4		76.6		24.4	
7102L_20	20		15.9		1 3/8	34.9	34.5		44.6		69.0		89.3		26.0	
7102L_22	22		18.3		1 3/8	34.9	34.6		44.7		69.1		89.4		26.0	
7102L_25	25		21.8		1 3/8	34.9	36.8		49.1		73.7		98.3		31.3	

## ALL TUBES (INCH)

Ordering Information	A Tube O.D.		D		W Wrench Flat		N		E		M		L		I	
	inch	mm	inch	mm	inch	mm	inch	mm	inch	mm	inch	mm	inch	mm	inch	mm
7102L_1/8	1/8	3.17	.09	2.28	3/8	9.5	.62	15.74	.88	22.35	1.24	31.48	1.76	44.70	.50	12.7
7102L_1/4	1/4	6.35	.19	4.82	1/2	12.7	.77	19.56	1.06	26.92	1.54	39.12	2.12	53.84	.60	15.2
7102L_5/16	5/16	7.93	.25	6.35	5/8	15.9	.88	22.35	1.17	29.71	1.76	44.70	2.34	59.42	.64	16.2
7102L_3/8	3/8	9.52	.28	7.11	5/8	15.9	.91	23.11	1.20	30.48	1.82	46.22	2.40	60.96	.66	16.8
7102L_1/2	1/2	12.70	.41	10.41	13/16	20.6	1.02	25.9	1.42	36.07	2.04	51.80	2.84	72.14	.90	22.9
7102L_3/4	3/4	19.05	.62	15.74	1 1/16	27.0	1.17	29.72	1.57	39.88	2.34	59.44	3.14	79.76	.96	24.4
7102L_1	1	25.40	.88	22.35	1 3/8	34.9	1.45	36.8	1.93	49.02	2.90	73.60	3.86	98.04	1.23	31.2

"D" - Dimension is minimum opening. Dimensions are for reference only and subject to change without notice.

# 7108 L CAP

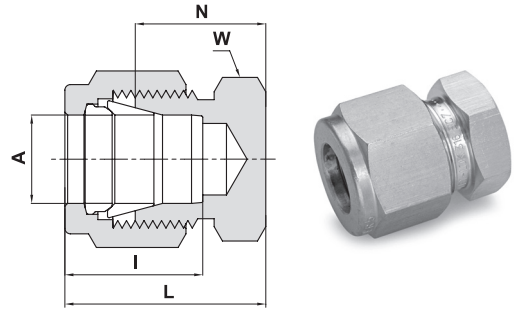

## CAPPING END OF TUBE (METRIC)

Ordering Information	A Tube O.D.		W Hex. Flat		N		L		I	
	mm		mm		mm		mm		mm	
7108L_2	2		12		13.5		20.1		12.9	
7108L_3	3		12		13.5		20.1		12.9	
7108L_4	4		12		14.7		21.3		13.7	
7108L_6	6		14		15.7		23.1		15.3	
7108L_8	8		15		17.0		24.5		16.2	
7108L_10	10		18		19.0		26.6		17.2	
7108L_12	12		22		19.0		29.1		22.8	
7108L_14	14		24		19.8		29.9		24.4	
7108L_15	15		24		19.8		29.9		24.4	
7108L_16	16		24		19.8		29.9		24.4	
7108L_18	18		27		21.3		31.4		24.4	
7108L_20	20		30		23.9		34.0		26.0	
7108L_22	22		30		23.9		34.0		26.0	
7108L_25	25		35		26.2		38.5		31.3	
7108L_38	38*		55		37.8		65.4		49.4	

## CAPPING END OF TUBE (INCH)

Ordering Information	A Tube O.D.		W Hex. Flat		N		L		I	
	inch	mm	inch	mm	inch	mm	inch	mm	inch	mm
7108L_1/16	1/16	1.58	5/16		.44	11.17	.59	14.98	.34	8.6
7108L_1/8	1/8	3.17	7/16		.53	13.46	.79	20.06	.50	12.7
7108L_3/16	3/16	4.76	7/16		.58	14.73	.84	21.84	.54	13.7
7108L_1/4	1/4	6.35	1/2		.63	16.00	.92	23.37	.60	15.2
7108L_5/16	5/16	7.93	9/16		.67	17.01	.96	24.38	.64	16.2
7108L_3/8	3/8	9.52	5/8		.72	18.28	1.01	26.65	.66	16.8
7108L_1/2	1/2	12.70	13/16		.75	19.05	1.15	29.21	.90	22.9
7108L_5/8	5/8	15.87	15/16		.78	19.81	1.18	29.97	.96	24.4
7108L_3/4	3/4	19.05	1 1/16		.84	21.33	1.24	31.49	.96	24.4
7108L_7/8	7/8	22.22	1 3/16		.94	23.88	1.34	34.04	1.02	25.9
7108L_1	1	25.40	1 3/8		1.03	26.16	1.51	38.35	1.23	31.2
7108L_1 1/4	1 1/4*	31.75	1 3/4		1.23	31.24	2.10	53.34	1.62	41.2
7108L_1 1/2	1 1/2*	38.10	2 1/8		1.47	37.33	2.54	64.52	1.97	50.0
7108L_2	2*	50.80	2 3/4		1.94	49.28	3.41	86.61	2.66	67.6

\* Including low friction paste, see page 101

"D" - Dimension is minimum opening. Dimensions are for reference only and subject to change without notice.

# 7121 L PLUG

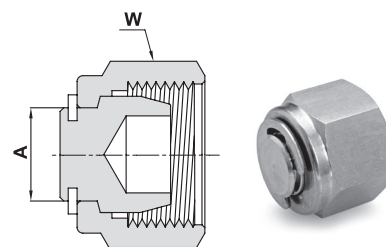

## METRIC

Ordering Information	A		W
	mm		Hex. Flat
7121L_2	2		14
7121L_3	3		12
7121L_4	4		12
7121L_6	6		14
7121L_8	8		16
7121L_10	10		19
7121L_12	12		22
7121L_14	14		25
7121L_15	15		25
7121L_16	16		25
7121L_18	18		30
7121L_20	20		32
7121L_22	22		32
7121L_25	25		38
7121L_38	38*		60
7121L_50	50*		3 inch

## PLUG ASSEMBLY INSTRUCTIONS

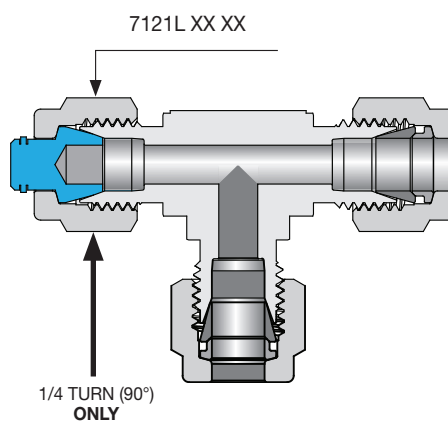

## INCH

Ordering Information	A		W
	inch	mm	Hex. Flat
7121L_1/16	1/16	1.58	5/16
7121L_1/8	1/8	3.17	7/16
7121L_3/16	3/16	4.76	1/2
7121L_1/4	1/4	6.35	9/16
7121L_5/16	5/16	7.93	5/8
7121L_3/8	3/8	9.52	11/16
7121L_1/2	1/2	12.70	7/8
7121L_5/8	5/8	15.87	1
7121L_3/4	3/4	19.05	1 1/8
7121L_7/8	7/8	22.22	1 1/4
7121L_1	1	25.40	1 1/2
7121L_1 1/4	1 1/4*	31.75	1 7/8
7121L_1 1/2	1 1/2*	38.10	2 1/4
7121L_2	2*	50.80	3 inch

\*Including low friction paste, (see page 101)

"D" - Dimension is minimum opening. Dimensions are for reference only and subject to change without notice.

## 7121 LANYARD PLUG WITH LANYARD

In order to secure the plug near the relevant fitting, UCT Fluid Solutions provides a plug secured with lanyard/wire, which keeps the plug nearby when not in use.

### METRIC

Ordering Information	W Hex Flat
	mm
7121L_3 Secur wire	12
7121L_4 Secur wire	12
7121L_6 Secur wire	14
7121L_8 Secur wire	16
7121L_10 Secur wire	19
7121L_12 Secur wire	22
7121L_14 Secur wire	25
7121L_15 Secur wire	25
7121L_16 Secur wire	25
7121L_18 Secur wire	30
7121L_20 Secur wire	32
7121L_22 Secur wire	32
7121L_25 Secur wire	38

### INCH

Ordering Information	W Hex Flat
	inch
7121L_1/8 Secur wire	7/16
7121L_3/16 Secur wire	1/2
7121L_1/4 Secur wire	9/16
7121L_5/16 Secur wire	5/8
7121L_3/8 Secur wire	11/16
7121L_1/2 Secur wire	7/8
7121L_5/8 Secur wire	1
7121L_3/4 Secur wire	1-1/8
7121L_7/8 Secur wire	1-1/4
7121L_1 Secur wire	1-1/2

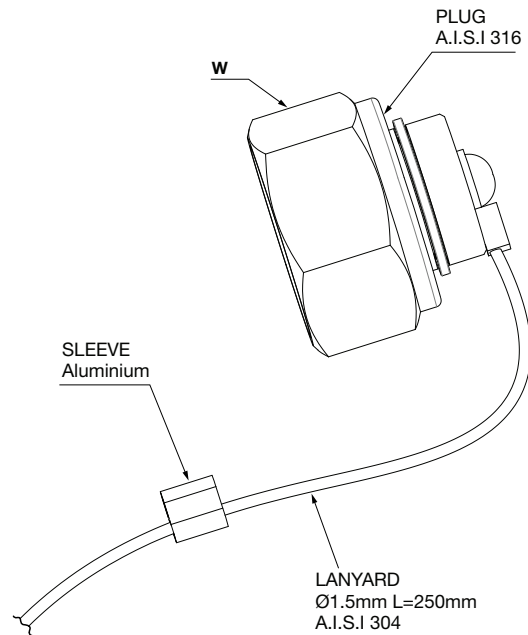
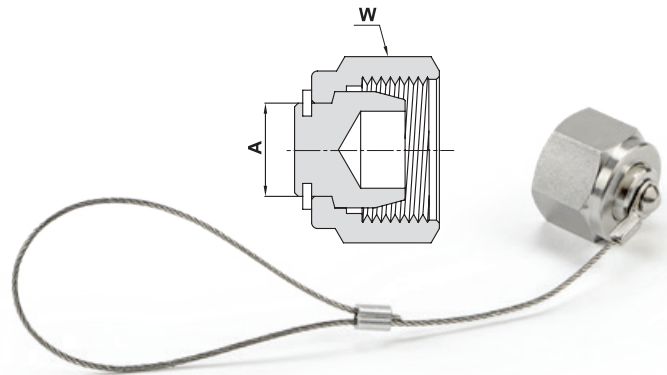



## 739 LF FEMALE ADAPTER TUBE TO PIPE

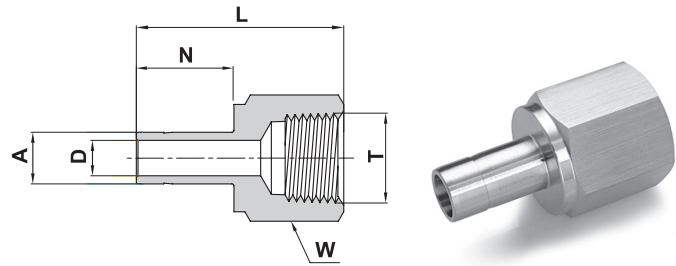

### TUBE (METRIC) FEMALE PIPE

Ordering Information	A Tube O.D.	T (NPT)	D	W Hex. Flat	N	L
	mm	inch	mm	mm	mm	mm
739LF _ 3 X 1/8	3	1/8	2.1	14	13.5	31.5
739LF _ 3 X 1/4	3	1/4	2.1	19	13.5	35.3
739LF _ 4 X 1/4	4	1/4	2.2	19	14.2	35.0
739LF _ 6 X 1/8	6	1/8	4.0	14	15.7	32.5
739LF _ 6 X 1/4	6	1/4	4.0	19	15.7	37.1
739LF _ 6 X 3/8	6	3/8	4.0	22	15.7	39.6
739LF _ 6 X 1/2	6	1/2	4.0	27	15.7	45.5
739LF _ 8 X 1/8	8	1/8	5.6	14	16.8	34.3
739LF _ 8 X 1/4	8	1/4	5.6	19	16.8	37.6
739LF _ 8 X 1/2	8	1/2	5.6	27	16.8	46.0
739LF _ 10 X 1/4	10	1/4	7.1	19	17.5	38.1
739LF _ 10 X 3/8	10	3/8	7.1	22	17.5	40.1
739LF _ 10 X 1/2	10	1/2	7.1	27	17.5	46.5
739LF _ 12 X 1/4	12	1/4	8.8	19	23.1	43.4
739LF _ 12 X 3/8	12	3/8	8.8	22	23.1	45.5
739LF _ 12 X 1/2	12	1/2	8.8	27	23.1	52.3
739LF _ 16 X 3/8	16	3/8	12.7	24	24.7	48.0
739LF _ 16 X 1/2	16	1/2	12.7	27	24.7	53.1
739LF _ 20 X 1/2	20	1/2	15.1	27	26.6	56.0
739LF _ 20 X 3/4	20	3/4	15.1	35	26.6	56.0

"D" - Dimension is minimum opening. Dimensions are for reference only and subject to change without notice.

Cont'd next page

**739 LF**  
**FEMALE ADAPTER**  
**TUBE TO PIPE** (Cont'd)

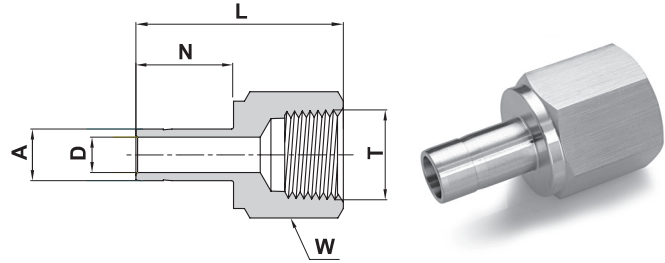

**TUBE (INCH) FEMALE PIPE**

Ordering Information	A Tube O.D.		T (NPT)	D		W Hex. Flat	N		L	
	inch	mm	inch	inch	mm	inch	inch	mm	inch	mm
739LF _ 1/8 X 1/8	1/8	3.17	1/8	.08	2.0	9/16	.53	13.45	1.24	31.5
739LF _ 1/8 X 1/4	1/8	3.17	1/4	.08	2.0	3/4	.53	13.45	1.39	35.3
739LF _ 3/16 X 1/4	3/16	4.76	1/4	.12	3.0	3/4	.56	14.20	1.41	35.8
739LF _ 1/4 X 1/8	1/4	6.35	1/8	.17	4.2	9/16	.62	15.75	1.30	33.0
739LF _ 1/4 X 1/4	1/4	6.35	1/4	.17	4.2	3/4	.62	15.75	1.46	37.1
739LF _ 1/4 X 3/8	1/4	6.35	3/8	.17	4.2	7/8	.62	15.75	1.55	39.4
739LF _ 1/4 X 1/2	1/4	6.35	1/2	.17	4.2	1 1/16	.62	15.75	1.79	45.5
739LF _ 5/16 X 1/4	5/16	7.93	1/4	.22	5.6	3/4	.66	16.75	1.48	37.6
739LF _ 3/8 X 1/8	3/8	9.52	1/8	.27	6.9	9/16	.69	17.50	1.35	34.3
739LF _ 3/8 X 1/4	3/8	9.52	1/4	.27	6.9	3/4	.69	17.50	1.50	38.1
739LF _ 3/8 X 3/8	3/8	9.52	3/8	.27	6.9	7/8	.69	17.50	1.59	40.4
739LF _ 3/8 X 1/2	3/8	9.52	1/2	.27	6.9	1 1/16	.69	17.50	1.84	46.7
739LF _ 1/2 X 1/4	1/2	12.70	1/4	.37	9.4	3/4	.91	23.10	1.71	43.4
739LF _ 1/2 X 3/8	1/2	12.70	3/8	.37	9.4	7/8	.91	23.10	1.79	45.5
739LF _ 1/2 X 1/2	1/2	12.70	1/2	.37	9.4	1 1/16	.91	23.10	2.05	52.1
739LF _ 5/8 X 1/2	5/8	15.87	1/2	.50	12.7	1 1/16	.97	24.65	2.09	53.1
739LF _ 3/4 X 1/2	3/4	19.05	1/2	.59	15.0	1 1/16	.97	24.65	2.08	52.8
739LF _ 3/4 X 3/4	3/4	19.05	3/4	.59	15.0	1 5/16	.97	24.65	2.16	54.9
739LF _ 3/4 X 1	3/4	19.05	1	.59	15.0	1 5/8	.97	24.65	2.30	58.4
739LF _ 1 X 3/4	1	25.40	3/4	.80	20.3	1 5/16	1.23	31.20	2.39	60.7
739LF _ 1 X 1	1	25.40	1	.80	20.3	1 5/8	1.23	31.20	2.53	64.3
739LF _ 1 1/4 X 1 1/4	1 1/4*	31.75	1 1/4	1.02	25.9	2 1/8	1.73	43.82	3.06	77.7
739LF _ 1 1/2 X 1 1/2	1 1/2*	38.10	1 1/2	1.25	31.8	2 3/8	2.14	54.33	3.50	88.9

\*Supplied assembled with Nut and Ferrules. Including low friction paste (see page 101).

"D" - Dimension is minimum opening. Dimensions are for reference only and subject to change without notice.

# 739 LM MALE ADAPTER TUBE TO PIPE

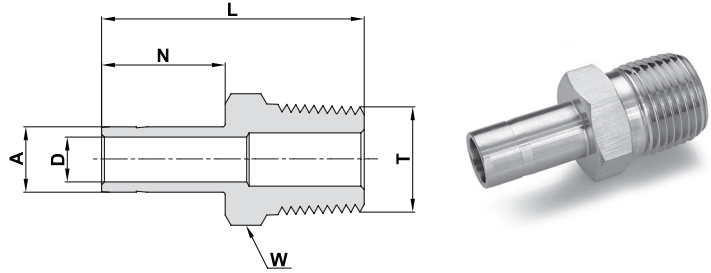

## TUBE (METRIC) MALE PIPE

Ordering Information	A Tube O.D.	T (NPT)	D	W Hex. Flat	N	L
	mm	inch	mm	mm	mm	mm
739LM _ 3 X 1/8	3	1/8	2.1	12	13.5	30.0
739LM _ 3 X 1/4	3	1/4	2.1	14	13.5	35.3
739LM _ 6 X 1/8	6	1/8	4.0	12	15.7	32.8
739LM _ 6 X 1/4	6	1/4	4.0	14	15.7	38.1
739LM _ 6 X 3/8	6	3/8	4.0	18	15.7	37.0
739LM _ 6 X 1/2	6	1/2	4.0	22	15.7	43.4
739LM _ 8 X 1/8	8	1/8	4.8	12	16.8	33.5
739LM _ 8 X 1/4	8	1/4	5.6	14	16.8	39.1
739LM _ 8 X 3/8	8	3/8	5.6	11/16 inch	16.8	37.8
739LM _ 8 X 1/2	8	1/2	5.6	22	16.8	43.0
739LM _ 10 X 1/4	10	1/4	7.1	9/16 inch	17.5	39.9
739LM _ 10 X 3/8	10	3/8	7.1	18	17.5	40.6
739LM _ 10 X 1/2	10	1/2	7.1	22	17.5	46.2
739LM _ 12 X 1/4	12	1/4	7.1	16	23.1	46.5
739LM _ 12 X 3/8	12	3/8	8.8	18	23.1	46.5
739LM _ 12 X 1/2	12	1/2	8.8	22	23.1	52.0
739LM _ 16 X 1/2	16	1/2	11.9	22	24.7	50.5
739LM _ 20 X 3/4	20	3/4	15.1	27	26.6	54.3

"D" - Dimension is minimum opening. Dimensions are for reference only and subject to change without notice.

Cont'd next page

**739 LM**  
**MALE ADAPTER**  
**TUBE TO PIPE** (Cont'd)

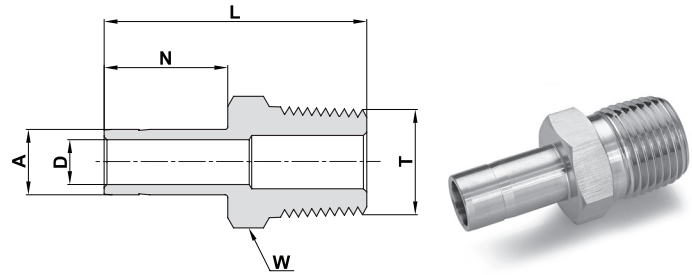

**TUBE (INCH) MALE PIPE**

Ordering Information	A Tube O.D.		T (NPT)	D		W Hex. Flat	N		L	
	inch	mm	inch	inch	mm	inch	inch	mm	inch	mm
739LM _ 1/8 X 1/8	1/8	3.17	1/8	.08	2.0	7/16	.53	13.45	1.16	29.5
739LM _ 1/8 X 1/4	1/8	3.17	1/4	.08	2.0	9/16	.53	13.45	1.37	34.8
739LM _ 3/16 X 1/8	3/16	4.76	1/8	.12	3.0	7/16	.56	14.20	1.19	30.2
739LM _ 3/16 X 1/4	3/16	4.76	1/4	.12	3.0	9/16	.56	14.20	1.40	35.6
739LM _ 1/4 X 1/8	1/4	6.35	1/8	.17	4.2	7/16	.62	15.75	1.25	31.8
739LM _ 1/4 X 1/4	1/4	6.35	1/4	.17	4.2	9/16	.62	15.75	1.46	37.1
739LM _ 1/4 X 3/8	1/4	6.35	3/8	.17	4.2	11/16	.62	15.75	1.49	37.9
739LM _ 1/4 X 1/2	1/4	6.35	1/2	.17	4.2	7/8	.62	15.75	1.71	43.4
739LM _ 5/16 X 1/8	5/16	7.93	1/8	.22	5.6	7/16	.66	16.75	1.29	32.7
739LM _ 5/16 X 1/4	5/16	7.93	1/4	.22	5.6	9/16	.66	16.75	1.50	38.1
739LM _ 3/8 X 1/8	3/8	9.52	1/8	.27	6.9	7/16	.69	17.50	1.32	33.5
739LM _ 3/8 X 1/4	3/8	9.52	1/4	.27	6.9	9/16	.69	17.50	1.53	38.9
739LM _ 3/8 X 3/8	3/8	9.52	3/8	.27	6.9	11/16	.69	17.50	1.56	39.6
739LM _ 3/8 X 1/2	3/8	9.52	1/2	.27	6.9	7/8	.69	17.50	1.78	45.2
739LM _ 1/2 X 1/4	1/2	12.70	1/4	.28	7.1	9/16	.91	23.10	1.75	44.5
739LM _ 1/2 X 3/8	1/2	12.70	3/8	.37	9.4	11/16	.91	23.10	1.78	45.2
739LM _ 1/2 X 1/2	1/2	12.70	1/2	.37	9.4	7/8	.91	23.10	2.0	50.8
739LM _ 5/8 X 3/8	5/8	15.87	3/8	.37	9.5	11/16	.97	24.65	1.81	47.6
739LM _ 5/8 X 1/2	5/8	15.87	1/2	.47	11.9	7/8	.97	24.65	2.06	52.3
739LM _ 5/8 X 3/4	5/8	15.87	3/4	.50	12.7	1 1/16	.97	24.65	2.06	52.3
739LM _ 3/4 X 1/2	3/4	19.05	1/2	.47	11.9	7/8	.97	24.65	2.06	52.3
739LM _ 3/4 X 3/4	3/4	19.05	3/4	.59	15.0	1 1/16	.97	24.65	2.06	52.3
739LM _ 3/4 X 1	3/4	19.05	1	.59	15.0	1 3/8	.97	24.65	2.28	57.3
739LM _ 7/8 X 3/4	7/8	22.22	3/4	.60	15.9	1 1/16	1.05	26.60	2.09	54.3
739LM _ 1 X 3/4	1	25.40	3/4	.60	15.8	1 1/16	1.30	33.00	2.31	58.7
739LM _ 1 X 1	1	25.40	1	.80	20.3	1 3/8	1.30	33.00	2.60	66.0
739LM _ 1 1/4 X 1 1/4	* 1 1/4	31.75	1 1/4	1.02	25.9	1 3/4	1.73	43.82	3.16	80.3
739LM _ 1 1/2 X 1 1/2	* 1 1/2	38.10	1 1/2	1.25	31.6	2 1/8	2.14	54.33	3.72	94.5

\*Supplied assembled with Nut and Ferrules. Including low friction paste (see page 98)

"D" - Dimension is minimum opening. Dimensions are for reference only and subject to change without notice.

# 739 LMR MALE ADAPTER TUBE TO PIPE

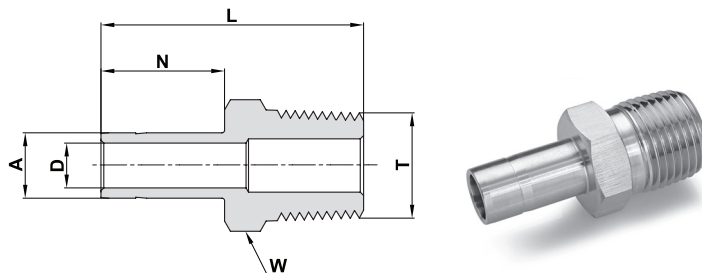

## TUBE (METRIC) MALE PIPE

Ordering Information	A Tube O.D		T (ISO)	D		W Hex. Flat	N		L	
	mm	inch	inch	mm	mm	mm	mm	mm	mm	
739LMR _ 6 X 1/8	6	R-1/8	4.0	12	15.7	32.8				
739LMR _ 6 X 1/4	6	R-1/4	4.0	14	15.7	38.1				
739LMR _ 6 X 1/2	6	R-1/2	4.0	22	15.7	43.4				
739LMR _ 8 X 1/8	8	R-1/8	4.8	12	16.8	33.5				
739LMR _ 8 X 1/4	8	R-1/4	5.6	14	16.8	39.1				
739LMR _ 8 X 3/8	8	R-3/8	5.6	11/16 inch	16.8	37.8				
739LMR _ 10 X 1/4	10	R-1/4	7.1	14	17.5	39.9				
739LMR _ 10 X 3/8	10	R-3/8	7.1	18	17.5	40.6				
739LMR _ 10 X 1/2	10	R-1/2	7.1	22	17.5	46.2				
739LMR _ 12 X 1/4	12	R-1/4	7.1	16	23.1	46.5				
739LMR _ 12 X 3/8	12	R-3/8	8.8	18	23.1	46.2				
739LMR _ 12 X 1/2	12	R-1/2	8.8	22	23.1	52.0				
739LMR _ 20 X 3/4	20	R-3/4	15.1	27	26.6	54.3				

## TUBE (INCH) MALE PIPE

Ordering Information	A Tube O.D		T (ISO)	D		W Hex. Flat	N		L	
	inch	mm	inch	inch	mm	inch	inch	mm	inch	mm
739LMR _ 1/8 X 1/8	1/8	3.17	R-1/8	.08	2.0	7/16	.53	13.45	1.16	29.5
739LMR _ 1/8 X 1/4	1/8	3.17	R-1/4	.08	2.0	9/16	.53	13.45	1.37	34.8
739LMR _ 1/4 X 1/8	1/4	6.35	R-1/8	.17	4.2	7/16	.62	15.75	1.25	31.8
739LMR _ 1/4 X 1/4	1/4	6.35	R-1/4	.17	4.2	9/16	.62	15.75	1.46	37.1
739LMR _ 1/4 X 3/8	1/4	6.35	R-3/8	.17	4.2	11/16	.62	15.75	1.49	37.9
739LMR _ 1/4 X 1/2	1/4	6.35	R-1/2	.17	4.2	7/8	.62	15.75	1.71	43.4
739LMR _ 3/8 X 1/4	3/8	9.52	R-1/4	.27	6.9	9/16	.69	17.50	1.53	38.9
739LMR _ 3/8 X 3/8	3/8	9.52	R-3/8	.27	6.9	11/16	.69	17.50	1.56	39.6
739LMR _ 3/8 X 1/2	3/8	9.52	R-1/2	.27	6.9	7/8	.69	17.50	1.78	45.2
739LMR _ 1/2 X 1/4	1/2	12.70	R-1/4	.28	7.1	9/16	.91	23.10	1.75	44.5
739LMR _ 1/2 X 3/8	1/2	12.70	R-3/8	.37	9.4	11/16	.91	23.10	1.78	45.2
739LMR _ 1/2 X 1/2	1/2	12.70	R-1/2	.37	9.4	7/8	.91	23.10	2.00	50.8
739LMR _ 5/8 X 1/2	5/8	15.87	R-1/2	.47	11.9	7/8	.97	24.65	2.06	52.3
739LMR _ 3/4 X 1/2	3/4	19.05	R-1/2	.47	11.9	7/8	.97	24.65	2.06	52.3
739LMR _ 3/4 X 3/4	3/4	19.05	R-3/4	.59	15.0	1 1/16	.97	24.65	2.06	52.3
739LMR _ 1 X 1	1	25.40	R-1	.80	20.3	1 3/8	1.30	33.00	2.60	66.0

### Reference Specifications:

DIN - ISO 2999  
BS - 21 JIS - B0203 ISO - 7/1-BSP-T

55° Thread angle  
Truncation of root and crest is round  
Taper angle 1°47'

### Designation:

Marking LR on Hex

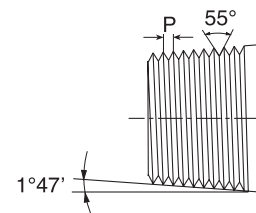

"D" - Dimension is minimum opening. Dimensions are for reference only and subject to change without notice.

# 739 LMG MALE ADAPTER TUBE TO PIPE

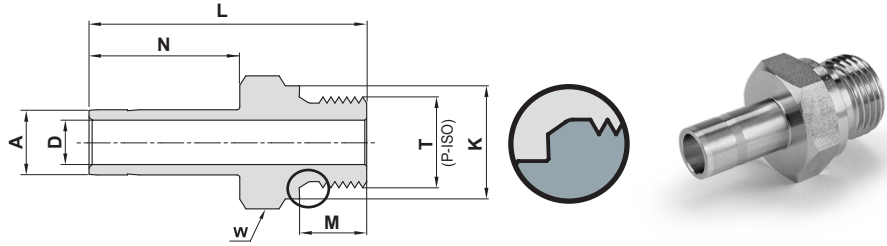

## TUBE (METRIC) TO ISO PARALLEL THREAD

Ordering Information	A Tube O.D		T (ISO)	D	K	W Hex. Flat	N	M	L
	mm	inch	mm	mm	mm	mm	mm	mm	mm
739LMG _ 6 X 1/8	6	G-1/8	4.0	13.8	9/16	15.7	7.1	30.4	
739LMG _ 6 X 1/4	6	G-1/4	4.0	18.0	19	15.7	11.2	38.9	
739LMG _ 8 X 1/4	8	G-1/4	5.6	18.0	19	16.8	11.2	40.1	
739LMG _ 10 X 1/4	10	G-1/4	5.9	18.0	19	17.5	11.2	40.9	
739LMG _ 10 X 3/8	10	G-3/8	7.1	21.8	22	17.5	11.2	41.7	
739LMG _ 10 X 1/2	10	G-1/2	7.1	26.0	27	17.5	14.2	44.7	
739LMG _ 12 X 1/4	12	G-1/4	6.4	18.0	19	23.1	11.2	47.0	
739LMG _ 12 X 3/8	12	G-3/8	7.9	21.8	22	23.1	11.2	47.2	
739LMG _ 12 X 1/2	12	G-1/2	8.8	26.0	27	23.1	14.2	50.5	
739LMG _ 18 X 1/2	18	G-1/2	11.9	26.0	27	24.6	14.2	51.3	
739LMG _ 18 X 3/4	18	G-3/4	13.9	32.0	35	24.6	15.7	55.9	
739LMG _ 38 X 1 1/2	38	G-1 1/2	31.6	54.7	55	52.8	22.1	91.9	

## TUBE (INCH) TO ISO PARALLEL THREAD

Ordering Information	A Tube O.D		T (ISO)	D	K	W Hex. Flat	N	M	L					
	inch	mm	inch	inch	mm	inch	mm	inch	mm					
739LMG _ 1/8 X 1/8	1/8	3.17	G-1/8	.08	2.0	.54	13.8	9/16	.53	13.45	.28	7.1	1.22	31.0
739LMG _ 1/8 X 1/4	1/8	6.35	G-1/4	.08	2.0	.71	18.0	3/4	.53	13.45	.44	11.2	1.41	35.8
739LMG _ 1/4 X 1/8	1/4	3.17	G-1/8	.16	4.0	.54	13.8	9/16	.62	15.75	.28	7.1	1.20	30.5
739LMG _ 1/4 X 1/4	1/4	6.35	G-1/4	.17	4.2	.71	18.0	3/4	.62	15.75	.44	11.2	1.42	36.0
739LMG _ 3/8 X 1/4	3/8	6.35	G-1/4	.23	5.8	.71	18.0	3/4	.69	17.50	.44	11.2	1.57	39.9
739LMG _ 3/8 X 3/8	3/8	9.52	G-3/8	.27	6.9	.86	21.8	7/8	.69	17.50	.44	11.2	1.60	40.6
739LMG _ 1/2 X 1/4	1/2	6.35	G-1/4	.23	5.8	.71	18.0	3/4	.91	23.10	.44	11.2	1.85	47.0
739LMG _ 1/2 X 3/8	1/2	9.52	G-3/8	.31	7.9	.86	21.8	7/8	.91	23.10	.44	11.2	1.88	47.7
739LMG _ 1/2 X 1/2	1/2	12.70	G-1/2	.37	9.4	1.02	26.0	1 1/16	.91	23.10	.56	14.2	1.96	49.8
739LMG _ 3/4 X 3/4	3/4	19.05	G-3/4	.59	15.0	1.26	32.0	1 5/16	.97	24.65	.62	15.7	2.16	54.9
739LMG _ 1 X 1	1	25.40	G-1	.78	19.8	1.54	39.0	1 5/8	1.23	31.20	.72	18.3	2.59	65.8

### Reference Specifications:

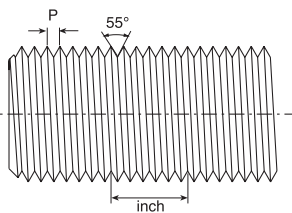

### Designation:

Marking LG on Hex.

\*Including low friction paste (See page 98).

"D" - Dimension is minimum opening.

Dimensions are for reference only and subject to change without notice.

For Parallel Threads Sealing  
(see page 82).

## 739 LN WELD ADAPTER TUBE TO PIPE

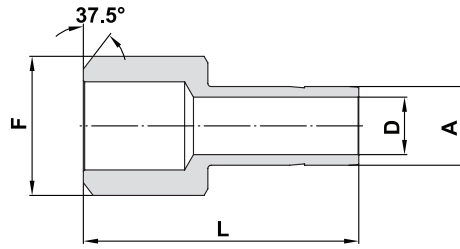

### TUBE (INCH)

Ordering Information	A Tube O.D.		F Pipe Size		D		L	
	inch	mm	inch	mm	inch	mm	inch	mm
739LN _ 1/4 X 1/4	1/4	6.35	1/4	13.70	.17	4.20	1.14	28.96
739LN _ 3/8 X 1/2	3/8	9.52	1/2	21.34	.27	6.85	1.46	37.08
739LN _ 1/2 X 1/2	1/2	12.7	1/2	21.34	.37	9.40	1.66	42.15
739LN _ 1/2 X 3/4	1/2	12.7	3/4	26.67	.37	9.40	1.68	42.67
739LN _ 3/4 X 3/4	3/4	19.05	3/4	26.67	.59	15.00	1.87	47.50

## 739 LW SOCKET WELD ADAPTER

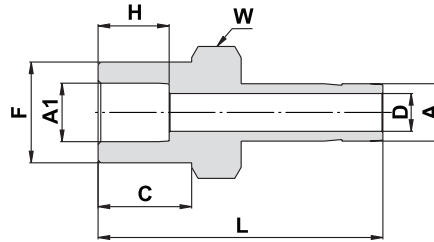

### TUBE (METRIC) TO TUBE (INCH)

Ordering Information	A Tube O.D.	A1 Pipe Size	C	D	W	F	H	L
	mm	inch	mm	mm	inch	mm	mm	mm
739LW _ 6 X 1/4	6	1/4	10.4	4.0	1/2	11.2	7.9	31.7
739LW _ 10 X 1/4	10	1/4	10.4	4.8	9/16	11.2	7.9	34.0
739LW _ 10 X 3/8	10	3/8	11.9	7.1	5/8	15.8	9.7	36.0

### TUBE (INCH) TO TUBE (INCH)

Ordering Information	A Tube O.D.		A1 Pipe Size		C		D		W		F		H		L	
	inch	mm	inch	mm	inch	mm	inch	mm	inch	mm	inch	mm	inch	mm	inch	mm
739LW _ 1/4 X 1/4	1/4	6.35	1/4	6.35	.41	10.41	.17	4.20	1/2	12.7	.44	11.18	.31	7.90	1.25	31.70
739LW _ 3/8 X 3/8	3/8	9.52	3/8	9.52	.47	11.94	.28	7.11	5/8	15.9	.62	15.75	.38	9.65	1.42	36.70
739LW _ 1/2 X 1/2	1/2	12.7	1/2	12.7	.47	11.94	.39	9.91	13/16	20.6	.75	19.05	.50	12.7	1.67	42.42

"D" - Dimension is minimum opening. Dimensions are for reference only and subject to change without notice.



## 739 LMOB MALE ADAPTER

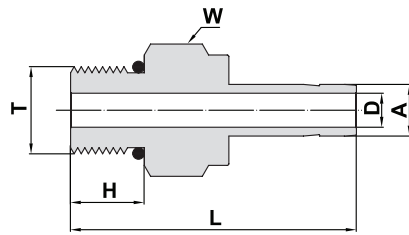

### TUBE (INCH) TO SAE/MS STRAIGHT THREAD BOSS\*\*\*

Ordering Information	A Tube O.D.		T Straight Thread UN	D		W		H		L		**O-Ring
	inch	mm	inch	inch	mm	inch	mm	inch	mm	inch	mm	
739LMOB _ 1/8 X 5/16-24	1/8	3.18	5/16-24	.08	2.03	7/16	11.1	.30	7.62	1.20	30.48	-902
739LMOB _ 1/4 X 7/16-20	1/4	6.35	7/16-20	.17	4.20	9/16	14.3	.36	9.14	1.39	35.3	-904
739LMOB _ 1/4 X 9/16-18	1/4	6.35	9/16-18	.17	4.20	11/16	17.5	.39	9.90	1.42	36.07	-906
739LMOB _ 3/8 X 7/16-20	3/8	9.52	7/16-20	.20	5.10	9/16	14.3	.36	9.14	1.46	37.08	-904
739LMOB _ 3/8 X 9/16-18	3/8	9.52	9/16-18	.27	6.85	11/16	17.5	.39	9.90	1.52	38.61	-906
739LMOB _ 3/8 X 3/4-16	3/8	9.52	3/4-16	.27	6.85	7/8	22.2	.44	11.17	1.60	40.64	-908
739LMOB _ 1/2 X 9/16-18	1/2	12.7	9/16-18	.28	7.11	11/16	17.5	.39	9.90	1.74	44.20	-906
739LMOB _ 1/2 X 3/4-16	1/2	12.7	3/4-16	.37	9.40	7/8	22.2	.44	11.17	1.82	46.23	-908
739LMOB _ 5/8 X 7/8-14	5/8	15.87	7/8-14	.47	11.94	1	25.4	.50	12.70	1.94	49.28	-910
739LMOB _ 3/4 X 1 1/16-12	3/4	19.05	1 1/16-12	.59	15.00	1 1/4	31.8	.59	14.98	2.10	53.34	-912
739LMOB _ 1 X 1 5/16-12	1	25.40	1 5/16-12	.80	20.32	1 1/2	38.1	.59	14.98	2.41	61.21	-916
739LMOB _ 1 1/4 X 1 5/8-12	1 1/4*	31.75	1 5/8-12	1.02	26.00	1 7/8	47.6	.59	15.10	2.81	71.37	-920
739LMOB _ 1 1/2 X 1 7/8-12	1 1/2 *	38.10	1 7/8-12	1.25	31.60	2 1/8	54.0	.59	15.10	3.28	83.31	-924

**Designation:** Marking LOB on Hex.

\*\*\*Per SAE J1926 and MS 16142. See page 53 for mounting dimensions.

\*\*Standard O-rings materials are Fluorocarbon FKM 90 Durometer. Other O-ring materials are available upon request.

\*Supplied assembled with Nut + Front and Back Ferrule. Including low friction paste, see page 101.

"D" - Dimension is minimum opening. Dimensions are for reference only and are subject to change without notice.

## 761 LFL LET-LOK® TO AN ADAPTER

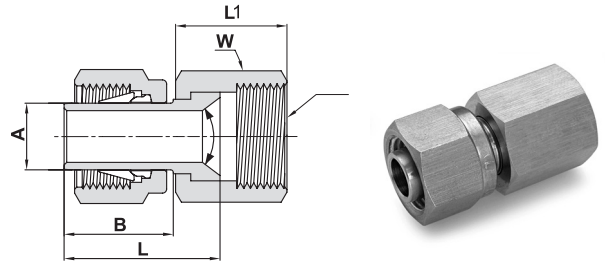

Ordering Information	A Tube O.D.		AN* Tube Flare Size		W Hex. Flat	L		L1		B	
	inch	mm	inch	mm	inch	inch	mm	inch	mm	inch	mm
761LFL _ 1/8 X 1/8	1/8	3.17	1/8	3.17	3/8	.75	19.05	.54	13.71	.53	13.46
761LFL _ 1/8 X 1/4	1/8	3.17	1/4	6.35	9/16	.75	19.05	.61	15.50	.53	13.46
761LFL _ 1/4 X 1/4	1/4	6.35	1/4	6.35	9/16	.84	21.33	.61	15.50	.62	15.75
761LFL _ 3/8 X 3/8	3/8	9.52	3/8	9.52	11/16	.98	24.89	.72	18.30	.69	17.53
761LFL _ 1/2 X 1/2	1/2	12.70	1/2	12.70	7/8	1.25	31.75	.84	21.30	.91	23.11

## 762 LFL LET-LOK® TO AN UNION

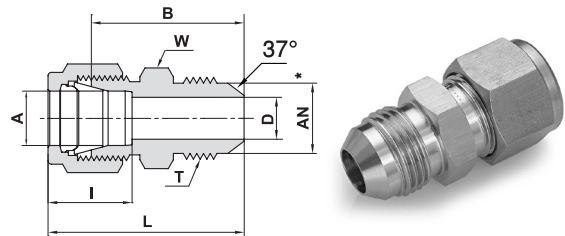

### TUBE (INCH) TO TUBE (INCH)

Ordering Information	A Tube O.D.		AN* Tube Flare size		D		W Hex. Flat	B		L		I	T Straight Thread	
	inch	mm	inch	mm	inch	mm	inch	inch	mm	inch	mm	inch	mm	
762LFL _ 1/16 X 1/8	1/16	1.58	1/8	3.17	.05	1.27	7/16	.92	23.36	1.07	27.18	.34	8.6	5/16-24
762LFL _ 1/8 X 1/8	1/8	3.17	1/8	3.17	.06	1.52	7/16	1.01	25.65	1.27	32.26	.50	12.7	5/16-24
762LFL _ 1/8 X 1/4	1/8	3.17	1/4	6.35	.09	2.28	1/2	1.12	28.44	1.38	35.05	.50	12.7	7/16-20
762LFL _ 1/4 X 1/4	1/4	6.35	1/4	6.35	.17	4.31	1/2	1.19	30.22	1.48	37.59	.60	15.2	7/16-20
762LFL _ 3/8 X 1/4	3/8	9.52	1/4	6.35	.17	4.31	5/8	1.27	32.25	1.56	39.62	.66	16.8	7/16-20
762LFL _ 3/8 X 3/8	3/8	9.52	3/8	9.52	.28	7.11	5/8	1.27	32.25	1.56	39.62	.66	16.8	9/16-18
762LFL _ 1/2 X 1/2	1/2	12.70	1/2	12.70	.39	9.90	13/16	1.41	35.8	1.81	45.96	.90	22.9	3/4-16
762LFL _ 3/4 X 3/4	3/4	19.05	3/4	19.05	.61	15.49	1 1/8	1.70	43.18	2.10	53.34	.96	24.4	1 1/16-12
762LFL _ 1 X 1	1	25.40	1	25.40	.84	21.34	1 3/8	1.94	49.28	2.42	61.47	1.23	31.2	1 5/16-12

## 774 LFL LET-LOK® TO AN BULKHEAD UNION

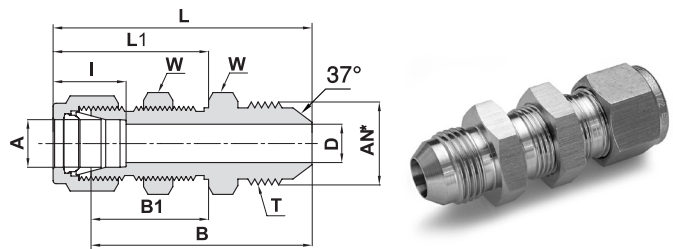

### TUBE (INCH) TO TUBE (INCH)

Ordering Information	A Tube O.D.		AN* Tube Flare size		D		W Hex. Flat		B		B1	L		L1	T Straight Thread	Panel Hole Drill Size	Max. Panel Thickness		I				
	inch	mm	inch	mm	inch	mm	inch	mm	inch	mm	inch	mm	mm	inch	mm	inch	mm	inch	mm				
774LFL _1/4 X 1/4	1/4	6.35	1/4	6.35	.17	4.30	5/8	15.9	1.83	46.48	1.03	26.16	2.12	53.84	1.32	33.52	7/16-20	29/64	11.50	.40	10.16	.60	15.2
774LFL _3/8 X 3/8	3/8	9.52	3/8	9.52	.28	7.11	3/4	19.1	1.96	49.78	1.16	29.46	2.25	57.15	1.45	36.83	9/16-18	37/64	14.68	.44	11.17	.66	16.8
774LFL _1/2 X 1/2	1/2	12.70	1/2	12.70	.39	9.90	15/16	23.8	2.19	55.63	1.25	31.75	2.59	65.79	1.65	41.91	3/4-16	49/64	19.45	.50	12.70	.90	22.9
774LFL _3/4 X 3/4	3/4	19.05	3/4	19.05	.61	15.49	1 3/16	30.2	2.71	68.83	1.47	37.34	3.11	78.99	1.87	47.50	1 1/16-12	1 1/64	25.80	.66	16.76	.96	24.4
774LFL _1 X 1	1	25.40	1	25.40	.84	21.33	1 5/8	41.3	3.16	80.26	1.78	45.21	3.64	92.46	2.26	57.40	1 5/16-12	1 21/64	33.73	.75	19.05	.23	31.2

\*Flare 37° per SAE J514.

"D" - Dimension is minimum opening. Dimensions are for reference only and subject to change without notice.

739 LTFL

**MALE ADAPTER  
TUBE TO AN**

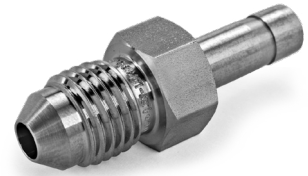
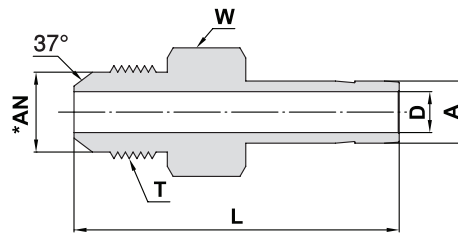

**TUBE (INCH) TO TUBE (INCH)**

Ordering Information	A Tube O.D.		AN* Thread Flare Size		D		W		L		T Straight Thread
	inch	mm	inch	mm	inch	mm	inch	mm	inch	mm	
739LTFL_ 1/4 X 1/4	1/4	6.35	1/4	6.35	.17	4.20	1/2	12.7	1.46	37.08	7/16-20
739LTFL_ 3/8 X 1/4	3/8	9.52	1/4	6.35	.17	4.20	1/2	12.7	1.53	38.86	7/16-20
739LTFL_ 3/8 X 3/8	3/8	9.52	3/8	9.52	.28	7.11	5/8	15.9	1.56	39.62	9/16-18
739LTFL_ 1/2 X 1/2	1/2	12.7	1/2	12.7	.39	9.90	13/16	20.6	1.91	48.51	3/4-16
739LTFL_ 5/8 X 5/8	5/8	15.87	5/8	15.87	.484	12.30	15/16	23.8	2.10	53.20	7/8-14
739LTFL_ 3/4 X 3/4	3/4	19.05	3/4	19.05	.59	15.00	1 1/8	28.6	2.21	56.13	1 1/16-12
739LTFL_ 1 X 1	1	25.40	1	25.40	.80	20.32	1 3/8	34.9	2.58	65.53	1 5/16-12

\* Flare 37° per SAE J514.

"D" - Dimension is minimum opening. Dimensions are for reference only and subject to change without notice.

# PARALLEL THREADS SEALING

Sealing the parallel thread as 228/1 is done on the shoulder, metal on metal or with the gasket (see tables below).

## SEALING WASHER FOR LG END

Bonded Stainless Steel / Carbon Steel Washer

## REFERENCE SPECIFICATIONS:

DIN - ISO 228/1  
 BS - 2779  
 JIS - B0202  
 ISO - 228/1-BSP-P

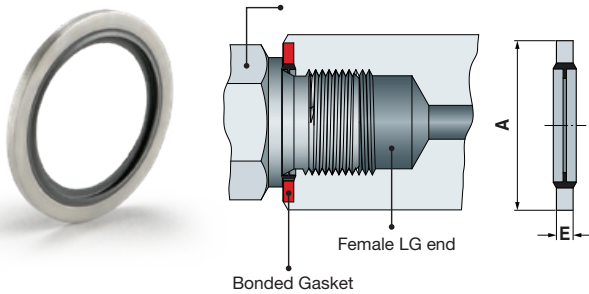

Ordering information		ISO Thread Size	A	E
Stainless Steel 316	Carbon Steel			
SS-GA-LG-1/8	S-GA-LG-1/8	1/8	15.88	2.03
SS-GA-LG-1/4	S-GA-LG-1/4	1/4	20.57	2.03
SS-GA-LG-3/8	S-GA-LG-3/8	3/8	23.80	2.03
SS-GA-LG-1/2	S-GA-LG-1/2	1/2	28.58	2.49
SS-GA-LG-3/4	S-GA-LG-3/4	3/4	34.93	2.49
SS-GA-LG-1	S-GA-LG-1	1	42.80	2.49

## HOW TO ORDER:

Example:

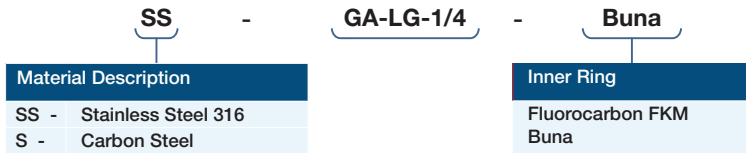

All orders should include material description and ordering information (see product table).

## Bonded Stainless Steel Washer Recommended in ISO 1179-1973

Compatible with end connections compliant with DIN 3852 Part 2.

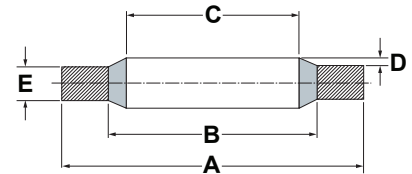

Ordering information	ISO Thread Size	A	B	C	D	E
SS-GA-LG-1/8-ISO-FKM	1/8	14.70	12.00	10.40	0.25	1.25
SS-GA-LG-1/4-ISO-FKM	1/4	18.70	15.75	13.85		
SS-GA-LG-3/8-ISO-FKM	3/8	22.70	19.25	17.35		
SS-GA-LG-1/2-ISO-FKM	1/2	26.70	23.55	21.65		
SS-GA-LG-3/4-ISO-FKM	3/4	32.50	29.20	27.30		
SS-GA-LG-1-ISO-FKM	1	39.50	36.10	34.20		2.00

**NOTE:** There is a permitted moulding flashline on the inner diameter C in accordance with AGS 1186. All dimensions in mm.

## COPPER SEAL GASKET LOK\* MALE END

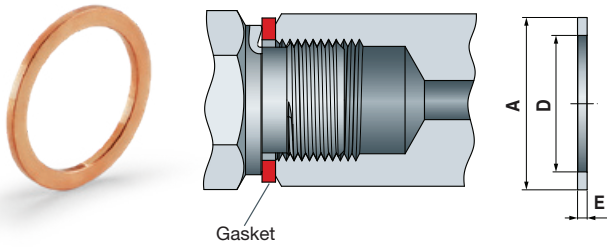

Ordering Information	ISO Thread Size	A		D		E	
		mm	inch	mm	inch	mm	inch
COPPER SEAL GASKET LOK 1/8	1/8	15.0	0.59	9.9	0.39	1.0	0.04
COPPER SEAL GASKET LOK 1/4	1/4	18.8	0.75	13.5	0.52	1.5	0.06
COPPER SEAL GASKET LOK 3/8	3/8	22.9	0.91	17.0	0.66	1.5	0.06
COPPER SEAL GASKET LOK 1/2	1/2	27	1.06	21.3	0.83	1.5	0.06
COPPER SEAL GASKET LOK 3/4	3/4	33.0	1.30	26.7	1.05	2.0	0.08
COPPER SEAL GASKET LOK 1	1	40.6	1.58	33.5	1.31	2.0	0.08

\* NOTE: Can be used on LG ends

## COPPER SEAL GASKET LG FEMALE END

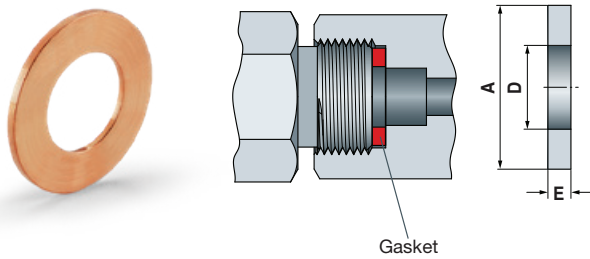

Ordering Information	ISO Thread Size	A		D		E	
		mm	inch	mm	inch	mm	inch
COPPER SEAL GASKET LG 1/4	1/4	10.7	0.42	7.6	0.30	1.8	0.07
COPPER SEAL GASKET LG 3/8	3/8	14.2	0.56	8.6	0.34	2.3	0.09
COPPER SEAL GASKET LG 1/2	1/2	17.8	0.70	9.1	0.36	2.5	0.10

# CHROMATOGRAPH FITTINGS

## 961 L MALE NUT

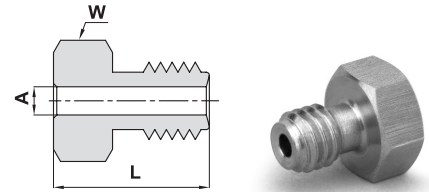

Ordering Information	A Tube O.D.		W Hex. Flat		L	
	inch	mm	inch	mm	inch	mm
961L_ 1/16	1/16	1.58	1/4	38.	9.50	

## 962 L UNION

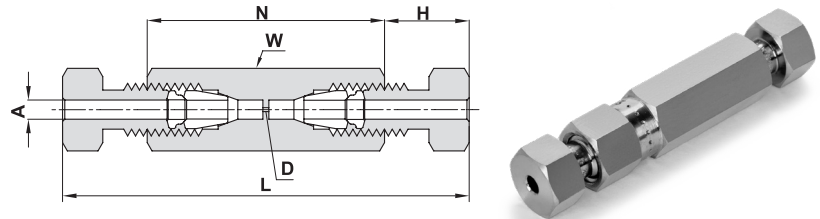

Ordering Information	A Tube O.D.		D		W Hex. Flat		N		H		L		Dead Space
	inch	mm	inch	mm	inch	mm	inch	mm	inch	mm	inch	mm	
962L_ 1/16	1/16	1.58	013.	33.	1/4	84.	21.34	20.	5.08	1.25	31.75	X 10 <sup>-5</sup> CC 6.6	

## 963 L REDUCING UNION

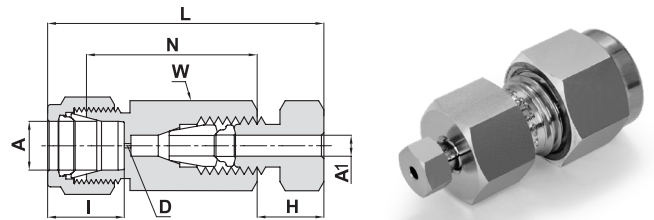

Ordering Information	A Tube O.D.		A1 Tube O.D.		D		W Hex. Flat		N		L		H		I		Dead Space
	inch	mm	inch	mm	inch	mm	inch	mm	inch	mm	inch	mm	inch	mm	inch	mm	
963L_ 1/4 X 1/16	1/4	6.35	1/16	1.58	013.	33.	1/2	75.	19.05	1.24	31.50	20.	5.08	60.	15.2	X 10 <sup>-5</sup> CC 6.8	
963L_ 3/8 X 1/16	3/8	9.52	1/16	1.58	013.	33.	5/8	81.	20.57	1.30	33.02	20.	5.08	66.	16.8	X 10 <sup>-5</sup> CC 6.8	

## 964 L UNION TEE

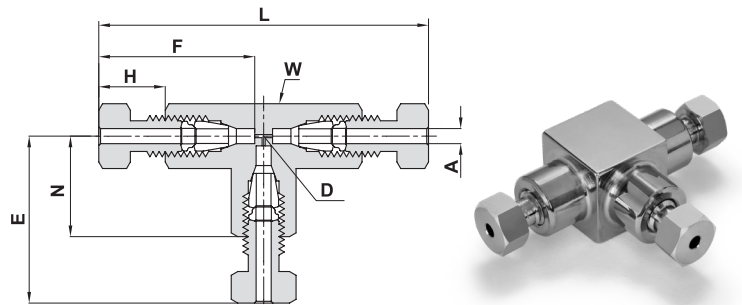

Ordering Information	A Tube O.D.		D		W Wrench Flat		N		H		F		E		L		Dead Space
	inch	mm	inch	mm	inch	mm	inch	mm	inch	mm	inch	mm	inch	mm	inch	mm	
964L_ 1/16	1/16	1.58	013.	33.	3/8	9.52	45.	11.43	20.	5.08	61.	15.49	65.	16.51	1.30	33.02	X 10 <sup>-4</sup> CC 2.8

"D" - Dimension is minimum opening. Dimensions are for reference only and are subject to change without notice.

# HAM-LET CALIBRATION FITTINGS

## 768LC MALE CONNECTOR

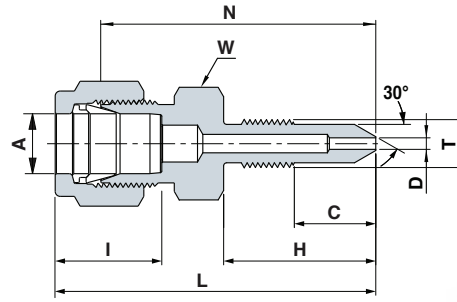

Ordering Information	A Tube O.D.		T Thread UN	D		W Wrench Flat	N		L		H		C		I	
	inch	mm	inch	inch	mm	inch	inch	mm	inch	mm	inch	mm	inch	mm	inch	mm
768LC SS 1/4 X 1/4-28	1/4	6.35	1/4-28	0.07	1.80	1/2	1.41	35.80	1.70	43.17	0.78	19.80	0.42	10.60	0.60	15.20

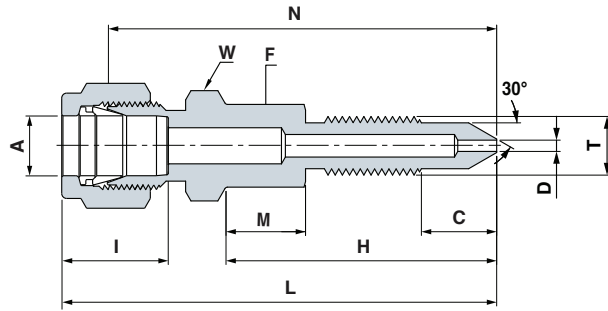

Ordering Information	A Tube O.D.		T Thread UN	D		W Wrench Flat	N		L		H		M		C		F		I	
	inch	mm	inch	inch	mm	inch	inch	mm	inch	mm	inch	mm	inch	mm	inch	mm	inch	mm	inch	mm
768LC SS 1/4 X 5/16-24	1/4	6.35	5/16-24	0.07	1.80	1/2	2.03	51.60	2.43	61.76	1.41	35.80	0.41	10.40	0.39	10.00	0.43	11.00	0.60	15.20





# ALLOY 400 NICKEL-COPPER

## ALLOY 400/R-405 CONNECTORS

Alloy 400, made of nickel-copper, is a solid-solution alloy that can be hardened only by cold working. It has high strength and toughness over a wide temperature range and excellent resistance to many corrosive environments. Alloy 400 is widely used in many fields, especially marine and chemical processing.

Back Ferrule* 760 LB		
	Ordering Information	Tube O.D.
		inch
	760LB M 1/4	1/4
	760LB M 3/8	3/8
	760LB M 1/2	1/2

Front Ferrule 760 LF		
	Ordering Information	Tube O.D.
		inch
	760LF M 1/4	1/4
	760LF M 3/8	3/8
	760LF M 1/2	1/2

Nut 761 L		
	Ordering Information	Tube O.D.
		inch
	761L M 1/4	1/4
	761L M 3/8	3/8
	761L M 1/2	1/2

Union 762 L		
	Ordering Information	Tube O.D.
		inch
	762L M 1/4	1/4
	762L M 3/8	3/8
	762L M 1/2	1/2

Union Tee 764 L		
	Ordering Information	Tube O.D.
		inch
	764L M 1/4	1/4
	764L M 3/8	3/8
	764L M 1/2	1/2

Union Elbow 765 L		
	Ordering Information	Tube O.D.
		inch
	765L M 1/4	1/4
	765L M 3/8	3/8
	765L M 1/2	1/2

Port Connector 767 LP		
	Ordering Information	Tube O.D.
		inch
	767LP M 1/4	1/4
	767LP M 3/8	3/8
	767LP M 1/2	1/2

Cap 7108 L		
	Ordering Information	Tube O.D.
		inch
	7108L M 1/4	1/4
	7108L M 3/8	3/8
	7108L M 1/2	1/2

Bulkhead Union 774 L		
	Ordering Information	Tube O.D.
		inch
	774L M 1/4	1/4
	774L M 3/8	3/8
	774L M 1/2	1/2

Plug 7121 L		
	Ordering Information	Tube O.D.
		inch
	7121L M 1/4	1/4
	7121L M 3/8	3/8
	7121L M 1/2	1/2

ALLOY 400 NICKEL-COPPER	
Barstock	Forging
ASTM B164	ASTM B564

### Reducer 767 LT

	Ordering Information	Tube O.D.	Tube O.D.
	767LT M 1/4 x 1/4	1/4	1/4
	767LT M 1/4 x 3/8	1/4	3/8
	767LT M 1/4 x 1/2	1/4	1/2
	767LT M 3/8 x 1/4	3/8	1/4
	767LT M 3/8 x 3/8	3/8	3/8
	767LT M 3/8 x 1/2	3/8	1/2
	767LT M 1/2 x 1/4	1/2	1/4
	767LT M 1/2 x 3/8	1/2	3/8
	767LT M 1/2 x 1/2	1/2	1/2

### Male Elbow 769 L

	Ordering Information	Tube O.D.	Male Pipe Size
	769L M 1/4 x 1/4	1/4	1/4
	769L M 3/8 x 1/4	3/8	1/4
	769L M 1/2 x 1/2	1/2	1/2

### Female Connector 766 L

	Ordering Information	Tube O.D.	Male Pipe Size
	766L M 1/4 x 1/4	1/4	1/4
	766L M 3/8 x 1/4	3/8	1/4

### Female Adapter 739 LF

	Ordering Information	Tube O.D.	Male Pipe Size
	739LF M 1/4 x 1/8	1/4	1/8
	739LF M 1/4 x 1/4	1/4	1/4
	739LF M 1/4 x 1/2	1/4	1/2
	739LF M 3/8 x 1/4	3/8	1/4
	739LF M 3/8 x 1/2	3/8	1/2
	739LF M 1/2 x 1/4	1/2	1/4
	739LF M 1/2 x 1/2	1/2	1/2

### Male Connector 768 L

	Ordering Information	Tube O.D.	Male Pipe Size
	768L M 1/4 x 1/8	1/4	1/8
	768L M 1/4 x 1/4	1/4	1/4
	768L M 1/4 x 3/8	1/4	3/8
	768L M 1/4 x 1/2	1/4	1/2
	768L M 3/8 x 1/4	3/8	1/4
	768L M 3/8 x 3/8	3/8	3/8
	768L M 3/8 x 1/2	3/8	1/2
	768L M 1/2 x 1/4	1/2	1/4
	768L M 1/2 x 3/8	1/2	3/8
	768L M 1/2 x 1/2	1/2	1/2
	768L M 1/2 x 3/4	1/2	3/4

### Male Adapter 739 LM

	Ordering Information	Tube O.D.	Male Pipe Size
	739LM M 1/4 x 1/8	1/4	1/8
	739LM M 1/4 x 1/4	1/4	1/4
	739LM M 1/4 x 3/8	1/4	3/8
	739LM M 1/4 x 1/2	1/4	1/2
	739LM M 3/8 x 1/4	3/8	1/4
	739LM M 3/8 x 3/8	3/8	3/8
	739LM M 3/8 x 1/2	3/8	1/2

## Let-Lok Tubing Data For Alloy 400

Alloy 400 UNS designatin N04400 tubes should be ordered according to ASTM B-165.

Hydraulic tubing is suitable for flaring and bending.

Tubing should be seamless and annealed.

Hardness: 75 HRB maximum

Tube O.D. inch	0.028	0.035	0.049	0.065
1/4	3700	4800	7000	9500
3/8		3100	4400	6100
1/2		2300	3200	4400

Allowable working pressure in psig at -20° to 100°F (-28° to 37°C)

### GAS APPLICATION TUBING

Tube O.D.	Min. Nominal wall thickness
1/2"	.035"

Dimensions are for reference only and subject to change without notice.

# ALLOY C-276 CONNECTORS

In aggressive/corrosive service, when nothing else works, many industries traditionally turn to **Alloy C-276**. Many years of outstanding performance in a variety of industrial applications confirmed the advantages of using this alloy.

## Excellent Resistance to Corrosion

**Alloy C-276** is a nickel-molybdenum-chromium wrought alloy that is generally considered a versatile corrosion-resistant alloy.

**C-276** alloy has excellent resistance to localized corrosion and to oxidizing and reducing media. C-276 alloy can be used in severe and corrosive environments because of its versatility.

**Alloy C-276** has excellent resistance to a wide variety of chemical process environments including strong oxidizers such as ferric and cupric chlorides, hot contaminated media (organic and inorganic), chlorine, formic and acetic acids, acetic anhydride, seawater and brine solutions. It is used in flue gas desulfurization systems because of its excellent resistance to sulfur compounds and chloride ions encountered in most scrubbers. **C-276** alloy has excellent resistance to pitting and to stress-corrosion cracking. Also, it is one of the few materials that withstands the corrosive effects of wet chlorine gas, hypochlorite and chlorine dioxide.

Back Ferrule 760 LB		
	Ordering Information	Tube O.D. inch
	760LB HC 1/4	1/4
	760LB HC 3/8	3/8
	760LB HC 1/2	1/2

Front Ferrule 760 LF		
	Ordering Information	Tube O.D. inch
	760LF HC 1/4	1/4
	760LF HC 3/8	3/8
	760LF HC 1/2	1/2

Nut 761 L		
	Ordering Information	Tube O.D. inch
	761L HC 1/4	1/4
	761L HC 3/8	3/8
	761L HC 1/2	1/2

Union 762 L		
	Ordering Information	Tube O.D. inch
	762L HC 1/4	1/4
	762L HC 3/8	3/8
	762L HC 1/2	1/2

Union Tee 764 L		
	Ordering Information	Tube O.D. inch
	764L HC 1/4	1/4
	764L HC 3/8	3/8
	764L HC 1/2	1/2

Union Elbow 765 L		
	Ordering Information	Tube O.D. inch
	765L HC 1/4	1/4
	765L HC 3/8	3/8
	765L HC 1/2	1/2

Port Connector 767 LP		
	Ordering Information	Tube O.D. inch
	767LP HC 1/4	1/4
	767LP HC 3/8	3/8
	767LP HC 1/2	1/2

Cap 7108 L		
	Ordering Information	Tube O.D. inch
	7108L HC 1/4	1/4
	7108L HC 3/8	3/8
	7108L HC 1/2	1/2

Bulkhead Union 774 L		
	Ordering Information	Tube O.D. inch
	774L HC 1/4	1/4
	774L HC 3/8	3/8
	774L HC 1/2	1/2

Plug 7121 L		
	Ordering Information	Tube O.D. inch
	7121L HC 1/4	1/4
	7121L HC 3/8	3/8
	7121L HC 1/2	1/2

ALLOY C-276 MATERIAL STD	
Barstock	Forging
ASTM B574	ASTM B564

### Reducer 767 LT

	Ordering Information	Tube O.D.	Tube O.D.
	767LT HC 1/4 x 1/4	1/4	1/4
767LT HC 1/4 x 3/8	1/4	3/8	
767LT HC 1/4 x 1/2	1/4	1/2	
767LT HC 3/8 x 1/4	3/8	1/4	
767LT HC 3/8 x 3/8	3/8	3/8	
767LT HC 3/8 x 1/2	3/8	1/2	
767LT HC 1/2 x 1/4	1/2	1/4	
767LT HC 1/2 x 3/8	1/2	3/8	
767LT HC 1/2 x 1/2	1/2	1/2	

### Male Elbow 769 L

	Ordering Information	Tube O.D.	Male Pipe Size
	769L HC 1/4 x 1/4	1/4	1/4
769L HC 3/8 x 1/4	3/8	1/4	
769L HC 1/2 x 1/2	1/2	1/2	

### Female Connector 766 L

	Ordering Information	Tube O.D.	Male Pipe Size
	766L HC 1/4 x 1/4	1/4	1/4
766L HC 3/8 x 1/4	3/8	1/4	

### Female Adapter 739 LF

	Ordering Information	Tube O.D.	Male Pipe Size
	739LF HC 1/4 x 1/8	1/4	1/8
739LF HC 1/4 x 1/4	1/4	1/4	
739LF HC 1/4 x 1/2	1/4	1/2	
739LF HC 3/8 x 1/4	3/8	1/4	
739LF HC 3/8 x 1/2	3/8	1/2	
739LF HC 1/2 x 1/4	1/2	1/4	
739LF HC 1/2 x 1/2	1/2	1/2	

### Male Connector 768 L

	Ordering Information	Tube O.D.	Male Pipe Size
	768L HC 1/4 x 1/8	1/4	1/8
768L HC 1/4 x 1/4	1/4	1/4	
768L HC 1/4 x 3/8	1/4	3/8	
768L HC 1/4 x 1/2	1/4	1/2	
768L HC 3/8 x 1/4	3/8	1/4	
768L HC 3/8 x 3/8	3/8	3/8	
768L HC 3/8 x 1/2	3/8	1/2	
768L HC 1/2 x 1/4	1/2	1/4	
768L HC 1/2 x 3/8	1/2	3/8	
768L HC 1/2 x 1/2	1/2	1/2	
768L HC 1/2 x 3/4	1/2	3/4	

### Male Adapter 739 LM

	Ordering Information	Tube O.D.	Male Pipe Size
	739LM HC 1/4 x 1/8	1/4	1/8
739LM HC 1/4 x 1/4	1/4	1/4	
739LM HC 1/4 x 1/2	1/4	1/2	
739LM HC 3/8 x 1/4	3/8	1/4	
739LM HC 3/8 x 1/2	3/8	1/2	
739LM HC 1/2 x 1/4	1/2	1/4	
739LM HC 1/2 x 1/2	1/2	1/2	

## Let-Lok Tubing Data For Alloy C-276

Alloy C-276 UNS designation N10276 tubes should be ordered according to ASTM B-622.

Hydraulic tubing is suitable for flaring and bending.

Tubing should be seamless and annealed.

Hardness: 100 HRB maximum

Tube O.D.	0.035	0.049	0.065
	Working Pressure (psig)		
1/4	5100	7500	10200
3/8	3300	4800	6500
1/2	2600	3700	5100

### GAS APPLICATION TUBING

Tube O.D.	Min. Nominal wall thickness
1/2"	.035"

Dimensions are for reference only and subject to change without notice.

# SUPER DUPLEX 2507 CONNECTORS

Duplex stainless-steels are becoming more common for a number of reasons:

- Higher strength levels
- Greater corrosion resistance-particularly Stress Corrosion Cracking (S.C.C.) in chloride-bearing environments.
- Much better resistance for localized corrosion such as pitting and crevice.

The “Pitting Resistances Equivalent Number” (P.R.E.N.) of “SD 2507” (1.4410/S32750) is roughly twice that of Austenitic Stainless Steels such as 304 (1.4301/S30400) or 316 (1.4401/S31600).

- High resistance to erosion-corrosion and corrosion-fatigue mechanism

Common designation/names/trade names include:

- SAF 2507
- UNS S32750
- EN#1.4410
- SD 2507

The nominal chemical composition of this alloy is 25% Chromium, 7% Nickel, 4% Molybdenum.

Test approvals: Norsok 650, Norsok 630

Back Ferrule 760 LB		
	Ordering Information	Tube O.D.
		inch
	760LB SD 1/4	1/4
	760LB SD 3/8	3/8
	760LB SD 1/2	1/2

Front Ferrule 760 LF		
	Ordering Information	Tube O.D.
		inch
	760LF SD 1/4	1/4
	760LF SD 3/8	3/8
	760LF SD 1/2	1/2

Nut 761 L		
	Ordering Information	Tube O.D.
		inch
	761L SD 1/4	1/4
	761L SD 3/8	3/8
	761L SD 1/2	1/2

Union 762 L		
	Ordering Information	Tube O.D.
		inch
	762L SD 1/4	1/4
	762L SD 3/8	3/8
	762L SD 1/2	1/2

Union Tee 764 L		
	Ordering Information	Tube O.D.
		inch
	764L SD 1/4	1/4
	764L SD 3/8	3/8
	764L SD 1/2	1/2

Union Elbow 765 L		
	Ordering Information	Male Pipe Size
		765L SD 1/4
	765L SD 3/8	3/8
	765L SD 1/2	1/2

Port Connector 767 LP		
	Ordering Information	Tube O.D.
		inch
	767LP SD 1/4	1/4
	767LP SD 3/8	3/8
	767LP SD 1/2	1/2

Cap 7108 L		
	Ordering Information	Tube O.D.
		inch
	7108L SD 1/4	1/4
	7108L SD 3/8	3/8
	7108L SD 1/2	1/2

Bulkhead Union 774 L		
	Ordering Information	Tube O.D.
		inch
	774L SD 1/4	1/4
	774L SD 3/8	3/8
	774L SD 1/2	1/2

Plug 7121 L		
	Ordering Information	Tube O.D.
		inch
	7121L SD 1/4	1/4
	7121L SD 3/8	3/8
	7121L SD 1/2	1/2

SUPER DUPLEX 2507 MATERIAL STD	
Barstock	Forging
ASTM A 479	ASTM A 182

Reducer 767 LT			
	Ordering Information	Tube O.D.	Tube O.D.
	767LT SD 1/4 X 3/8	1/4	3/8
	767LT SD 1/4 X 1/2	1/4	1/2
	767LT SD 3/8 X 1/4	3/8	1/4
	767LT SD 3/8 X 1/2	3/8	1/2
	767LT SD 1/2 X 1/4	1/2	1/4
	767LT SD 1/2 X 3/8	1/2	3/8

Male Elbow 769 L			
	Ordering Information	Tube O.D.	Male Pipe Size
	769L SD 1/4 X 1/4	1/4	1/4
	769L SD 3/8 X 3/8	3/8	1/4
	769L SD 1/2 X 1/2	1/2	1/2

Male Adapter 739 LMOB			
	Ordering Information	Tube O.D.	Male Pipe Size
	739LMOB SD 1/4 X 7/16-20	1/4	7/16-20
	739LMOB SD 3/8 X 7/16-20	3/8	7/16-20
	739LMOB SD 3/8 X 9/16-18	3/8	9/16-18
	739LMOB SD 1/2 X 9/16-18	1/2	9/16-18
	739LMOB SD 1/2 X 3/4-16	1/2	3/4-16

Male Connector 768 LOB			
	Ordering Information	Tube O.D.	Male Pipe Size
	768LOB SD 1/4 X 7/16-20	1/4	7/16-20
	768LOB SD 1/4 X 9/16-18	1/4	9/16-18
	768LOB SD 3/8 X 9/16-18	3/8	9/16-18
	768LOB SD 1/2 X 9/16-18	1/2	9/16-18
	768LOB SD 1/2 X 3/4-16	1/2	3/4-16

Female Adaptor 739 LF			
	Ordering Information	Tube O.D.	Female Pipe Size
	739LF SD 1/4 X 1/8	1/4	1/8
	739LF SD 1/4 X 1/4	1/4	1/4
	739LF SD 1/4 X 1/2	1/4	1/2
	739LF SD 3/8 X 1/4	3/8	1/4
	739LF SD 3/8 X 1/2	3/8	1/2
	739LF SD 1/2 X 1/4	1/2	1/4
	739LF SD 1/2 X 1/2	1/2	1/2

Male Connector 768 L			
	Ordering Information	Tube O.D.	Female Pipe Size
	768L SD 1/4 X 1/4	1/4	1/4
	768L SD 1/4 X 1/2	1/4	1/2
	768L SD 3/8 X 1/4	3/8	1/4
	768L SD 3/8 X 3/8	3/8	3/8
	768L SD 3/8 X 1/2	3/8	1/2
	768L SD 1/2 X 1/4	1/2	1/4
	768L SD 1/2 X 3/8	1/2	3/8
	768L SD 1/2 X 1/2	1/2	1/2

Male Adapter 739 LM			
	Ordering Information	Tube O.D.	Male Pipe Size
	739LM SD 1/4 X 1/4	1/4	1/4
	739LM SD 3/8 X 1/4	3/8	1/4
	739LM SD 3/8 X 3/8	3/8	3/8
	739LM SD 3/8 X 1/2	3/8	1/2
	739LM SD 1/2 X 1/4	1/2	1/4
	739LM SD 1/2 X 1/2	1/2	1/2

Union Cross 7102 L			
	Ordering Information	Tube O.D.	Male Pipe Size
	7102L SD 1/4	1/4	1/4
	7102L SD 3/8	3/8	1/4
	7102L SD 1/2	3/8	3/8

## Let-Lok Tubing Data For SAE Super Duplex 2507

Alloy 2507 UNS Designation S32750 tubes should be ordered according to ASTM A789 or equivalent.

Hydraulic tubing is suitable for bending, flaring and should be free of scratches. Tubing should be seamless and fully annealed.

Hardness: 32 HRC maximum

Tube O.D. inch	0.035	0.049	0.065
	Working Pressure (psig)		
1/4	10,000	15,000	-
3/8	6,500	10,000	12,700
1/2	5,000	7,200	10,000

Dimensions are for reference only and subject to change without notice.

# ALLOY 825 CONNECTORS

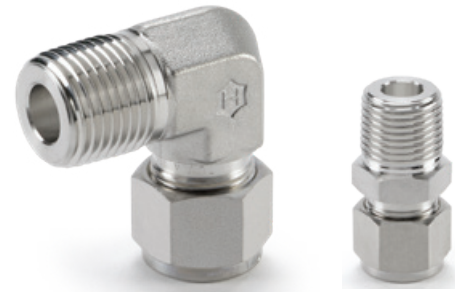

Alloy 825 (UNS Designation N08825) is a Nickel-Iron-Chromium Alloy with Molybdenum and Copper additives.

This alloy is designed to provide exceptional resistance in many corrosive environments along with an improved resistance to aqueous corrosive media.

It has excellent resistance to reducing and oxidizing acids, stress corrosion cracking and to localized attacks such as pitting and crevice corrosion.

Alloy 825 is especially resistant to sulfuric and phosphoric acid.

This alloy is used for chemical processing, pollution-control equipment, oil and gas systems as well as in the nuclear fuel reprocessing, acid production and pickling equipment such as heating coils and chains.

Back Ferrule 760 LB		
	Ordering Information	Tube O.D.
		inch
	760LB 825 1/4	1/4
	760LB 825 3/8	3/8
	760LB 825 1/2	1/2
	760LB 825 3/4	3/4

Front Ferrule 760 LF		
	Ordering Information	Tube O.D.
		inch
	760LF 825 1/4	1/4
	760LF 825 3/8	3/8
	760LF 825 1/2	1/2
	760LF 825 3/4	3/4

Nut 761 L		
	Ordering Information	Tube O.D.
		inch
	761L 825 1/4	1/4
	761L 825 3/8	3/8
	761L 825 1/2	1/2
	761L 825 3/4	3/4

Union 762 L		
	Ordering Information	Tube O.D.
		inch
	762L 825 1/4	1/4
	762L 825 3/8	3/8
	762L 825 1/2	1/2
	762L 825 3/4	3/4

Union Tee 764 L		
	Ordering Information	Tube O.D.
		inch
	764L 825 1/4	1/4
	764L 825 3/8	3/8
	764L 825 1/2	1/2
	764L 825 3/4	3/4

Union Elbow 765 L		
	Ordering Information	Tube O.D.
		inch
	765L 825 1/4	1/4
	765L 825 3/8	3/8
	765L 825 1/2	1/2
	765L 825 3/4	3/4

Port Connector 767 LP		
	Ordering Information	Tube O.D.
		inch
	767LP 825 1/4	1/4
	767LP 825 3/8	3/8
	767LP 825 1/2	1/2
	767LP 825 3/4	3/4

Cap 7108 L		
	Ordering Information	Tube O.D.
		inch
	7108L 825 1/4	1/4
	7108L 825 3/8	3/8
	7108L 825 1/2	1/2
	7108L 825 3/4	3/4

Bulkhead Union 774 L		
	Ordering Information	Tube O.D.
		inch
	774L 825 1/4	1/4
	774L 825 3/8	3/8
	774L 825 1/2	1/2
	774L 825 3/4	3/4

Plug 7121 L		
	Ordering Information	Tube O.D.
		inch
	7121L 825 1/4	1/4
	7121L 825 3/8	3/8
	7121L 825 1/2	1/2
	7121L 825 3/4	3/4

Male Elbow 769 L			
	Ordering Information	Tube O.D.	Male pipe size
		769L 825 1/4 X 1/4	1/4
	769L 825 3/8 X 3/8	3/8	3/8
	769L 825 1/2 X 1/2	1/2	1/2
	769L 825 3/4 X 3/4	3/4	3/4

ALLOY 825	
Barstock	Forging
ASTM B 425	ASTM B 564



### Reducer 767 LT

	Ordering Information	Tube O.D.	Tube O.D.
	767LT 825 1/4 X 3/8	1/4	3/8
767LT 825 1/4 X 1/2	1/4	1/2	
767LT 825 3/8 X 1/4	3/8	1/4	
767LT 825 3/8 X 1/2	3/8	1/2	
767LT 825 1/2 X 1/4	1/2	1/4	
767LT 825 1/2 X 3/8	1/2	3/8	
767LT 825 3/4 X 1/2	3/4	1/2	
767LT 825 3/4 X 3/4	3/4	3/4	

### Male Connector 768 L

	Ordering Information	Tube O.D.	Tube O.D.
	768L 825 1/4 X 1/4	1/4	1/4
768L 825 1/4 X 1/2	1/4	1/2	
768L 825 3/8 X 1/4	3/8	1/4	
768L 825 3/8 X 3/8	3/8	3/8	
768L 825 3/8 X 1/2	3/8	1/2	
768L 825 1/2 X 1/4	1/2	1/4	
768L 825 1/2 X 3/8	1/2	3/8	
768L 825 1/2 X 1/2	1/2	1/2	
768L 825 3/4 X 1/4	3/4	1/4	
768L 825 3/4 X 3/8	3/4	3/8	
768L 825 3/4 X 1/2	3/4	1/2	
768L 825 3/4 X 3/4	3/4	3/4	

### Male Adapter 739 LMOB

	Ordering Information	Tube O.D.	Tube O.D.
	739LMOB 825 1/4 X 7/16-20	1/4	7/16-20
739LMOB 825 3/8 X 7/16-20	3/8	7/16-20	
739LMOB 825 3/8 X 9/16-18	3/8	9/16-18	
739LMOB 825 1/2 X 9/16-18	1/2	9/16-18	
739LMOB 825 1/2 X 3/4-16	1/2	3/4-16	
739LMOB 825 3/4 X 3/4-16	3/4	3/4-16	
739LMOB 825 3/4 X 1-1/16-12	3/4	1-1/16-12	

### Male Adapter 739 LM

	Ordering Information	Tube O.D.	Male size
	739LM 825 1/4 X 1/4	1/4	1/4
739LM 825 3/8 X 1/4	3/8	1/4	
739LM 825 3/8 X 3/8	3/8	3/8	
739LM 825 3/8 X 1/2	3/8	1/2	
739LM 825 1/2 X 1/4	1/2	1/4	
739LM 825 1/2 X 1/2	1/2	1/2	
739LM 825 3/4 X 1/2	3/4	1/2	
739LM 825 3/4 X 3/4	3/4	3/4	

### Male Connector 768 LOB

	Ordering Information	Tube O.D.	Tube O.D.
	768LOB 825 1/4 X 7/16-20	1/4	7/16-20
768LOB 825 1/4 X 9/16-18	1/4	9/16-18	
768LOB 825 3/8 X 9/16-18	3/8	9/16-18	
768LOB 825 1/2 X 9/16-18	1/2	9/16-18	
768LOB 825 1/2 X 3/4-16	1/2	3/4-16	
768LOB 825 3/4 X 3/4-16	3/4	3/4-16	
768LOB 825 3/4 X 1-1/16-12	3/4	1-1/16-12	

### Union Cross 7102 L

	Ordering Information	Tube O.D.
	7102L 825 1/4	1/4
7102L 825 3/8	3/8	
7102L 825 1/2	1/2	
7102L 825 3/4	3/4	

### Male Connector 739 LF

	Ordering Information	Tube O.D.	Female Pipe Size
	739LF 825 1/4 X 1/8	1/4	1/8
739LF 825 1/4 X 1/4	1/4	1/4	
739LF 825 1/4 X 1/2	1/4	1/2	
739LF 825 3/8 X 1/4	3/8	1/4	
739LF 825 3/8 X 1/2	3/8	1/2	
739LF 825 1/2 X 1/4	1/2	1/4	
739LF 825 1/2 X 1/2	1/2	1/2	
739LF 825 3/4 X 1/2	3/4	1/2	
739LF 825 3/4 X 3/4	3/4	3/4	

## Let-Lok Tubing Data for Alloy 825

Alloy 825 UNS Designation N08825 tubes should be ordered according to ASTM B163, ASTM B423 or equivalent.

Suitable for bending, flaring and should be free of scratches.

Tubing should be seamless, high quality and bright fully annealed.

For fully annealed welded and cold drawn tube per ASTM B704 CLASS 1.

Multiply working pressure by 0.85

Hardness: 90 HR<sub>15T</sub> max or 201Hv max

Tube O.D.	0.035	0.049	0.065	0.083	0.095
	Working Pressure (psig)				
1/4	6,400	9,300	11,600		
3/8	4,100	5,900	8,200		
1/2	3,000	4,300	5,900		
3/4			3,800	4,900	5,800

# ALLOY 254 CONNECTORS



Alloy 254/254 SMO/6 Mo (UNS designation S31254) is an austenitic stainless steel with high molybdenum content, super austenitic which gives the alloy a very good resistance to pitting and crevice corrosion. It is especially useful in environments containing halide ions (chloride, bromide and fluoride solutions) such as brackish water, seawater, pulp mill bleach plants and other related high chloride processes.

SMO 254 characteristics include higher strength, higher resistance to abrasion, erosion and cavitation erosion when

compared to austenitic stainless steels such as 316 and 316L and also 317 or 317L. In addition to the above - SMO 254 offers excellent ductility and impact strength at both ambient and sub-zero temperatures.

SMO 254 covers a wide range of applications in several industries, such as chemical and food processing, oil and gas, pulp and paper mill, power generation and desalination plants.

Test approvals: Norsok 650, Norsok 630

Back Ferrule* 760 LB		
	Ordering Information	Tube O.D.
		inch
	760LB 254 1/4	1/4
	760LB 254 3/8	3/8
	760LB 254 1/2	1/2

Front Ferrule* 760 LF		
	Ordering Information	Tube O.D.
		inch
	760LF 254 1/4	1/4
	760LF 254 3/8	3/8
	760LF 254 1/2	1/2

Nut 761 L		
	Ordering Information	Tube O.D.
		inch
	761L 254 1/4	1/4
	761L 254 3/8	3/8
	761L 254 1/2	1/2

Union 762 L		
	Ordering Information	Tube O.D.
		inch
	762L 254 1/4	1/4
	762L 254 3/8	3/8
	762L 254 1/2	1/2

Union Tee 764 L		
	Ordering Information	Tube O.D.
		inch
	764L 254 1/4	1/4
	764L 254 3/8	3/8
	764L 254 1/2	1/2

Union Elbow 765 L		
	Ordering Information	Tube O.D.
		inch
	765L 254 1/4	1/4
	765L 254 3/8	3/8
	765L 254 1/2	1/2

Port Connector 767 LP		
	Ordering Information	Tube O.D.
		inch
	767LP 254 1/4	1/4
	767LP 254 3/8	3/8
	767LP 254 1/2	1/2

Cap 7108 L		
	Ordering Information	Tube O.D.
		inch
	7108L 254 1/4	1/4
	7108L 254 3/8	3/8
	7108L 254 1/2	1/2

Bulkhead Union 774 L		
	Ordering Information	Tube O.D.
		inch
	774L 254 1/4	1/4
	774L 254 3/8	3/8
	774L 254 1/2	1/2

Plug 7121 L		
	Ordering Information	Tube O.D.
		inch
	7121L 254 1/4	1/4
	7121L 254 3/8	3/8
	7121L 254 1/2	1/2

ALLOY 254 MATERIAL STD	
Barstock	Forging
ASTM A 479	ASTM A 182

### Reducer 767 LT

	Ordering Information	Tube O.D.	Tube O.D.
	767LT 254 1/4 X 3/8	1/4	3/8
767LT 254 1/4 X 1/2	1/4	1/2	
767LT 254 3/8 X 1/4	3/8	1/4	
767LT 254 3/8 X 1/2	3/8	1/2	
767LT 254 1/2 X 1/4	1/2	1/4	
767LT 254 1/2 X 3/8	1/2	3/8	
767LT 254 1/2 X 1/2	1/2	1/2	

### Male Connector 768 L

	Ordering Information	Tube O.D.	Tube O.D.
	768L 254 1/4 X 1/4	1/4	1/4
768L 254 1/4 X 1/2	1/4	1/2	
768L 254 3/8 X 1/4	3/8	1/4	
768L 254 3/8 X 3/8	3/8	3/8	
768L 254 3/8 X 1/2	3/8	1/2	
768L 254 1/2 X 1/4	1/2	1/4	
768L 254 1/2 X 3/8	1/2	3/8	
768L 254 1/2 X 1/2	1/2	1/2	

### Male Elbow 769 L

	Ordering Information	Tube O.D.	Male Pipe Size
	769L 254 1/4 X 1/4	1/4	3/8
769L 254 3/8 X 3/8	1/4	1/2	
769L 254 1/2 X 1/2	3/8	1/4	

### Male Adapter 739 LM

	Ordering Information	Tube O.D.	Male size
	739LM 254 1/4 X 1/4	1/4	1/4
739LM 254 3/8 X 1/4	3/8	1/4	
739LM 254 3/8 X 3/8	3/8	3/8	
739LM 254 3/8 X 1/2	3/8	1/2	
739LM 254 1/2 X 1/4	1/2	1/4	
739LM 254 1/2 X 1/2	1/2	1/2	

### Male Adapter 739 LMOB

	Ordering Information	Tube O.D.	Male size
	739LMOB 254 1/4 X 7/16-20	1/4	7/16-20
739LMOB 254 3/8 X 7/16-20	3/8	7/16-20	
739LMOB 254 3/8 X 9/16-18	3/8	9/16-18	
739LMOB 254 1/2 X 9/16-18	1/2	9/16-18	
739LMOB 254 1/2 X 3/4-16	1/2	3/4-16	

### Union Cross 7102 L

	Ordering Information	Tube O.D.
	7102L 254 1/4	1/4
7102L 254 3/8	3/8	
7102L 254 1/2	1/2	

### Male Connector 768 LOB

	Ordering Information	Tube O.D.	Tube O.D.
	768LOB 254 1/4 X 7/16-20	1/4	7/16-20
768LOB 254 1/4 X 9/16-18	1/4	9/16-18	
768LOB 254 3/8 X 9/16-18	3/8	9/16-18	
768LOB 254 1/2 X 9/16-18	1/2	9/16-18	
768LOB 254 1/2 X 3/4-16	1/2	3/4-16	

### Let-Lok Tubing Data for Alloy 254

Alloy 254 UNS Designation UNS S31254 tubes should be ordered according to ASTM A269 or ASTM A213 or equivalent.

Suitable for bending, flaring and should be free of scratches. Tubing should be seamless, high quality and bright annealed.

Hardness: 95HRB max.

### Male Connector 739 LF

	Ordering Information	Tube O.D.	Female Pipe Size
	739LF 254 1/4 X 1/8	1/4	1/8
739LF 254 1/4 X 1/4	1/4	1/4	
739LF 254 1/4 X 1/2	1/4	1/2	
739LF 254 3/8 X 1/4	3/8	1/4	
739LF 254 3/8 X 1/2	3/8	1/2	
739LF 254 1/2 X 1/4	1/2	1/4	
739LF 254 1/2 X 1/2	1/2	1/2	

Tube O.D.	0.035	0.049	0.065	0.083
	Working Pressure (psig)			
1/4	6,900	10,100	13,900	
3/8	4,500	6,500	8,900	
1/2	3,500	5,000	6,900	9,000

# DIELECTRIC FITTINGS

Dielectric fittings are designed to insulate subsystems from electrical currents, voltages and static charges.

## MATERIALS OF CONSTRUCTION

1. Body: A.I.S.I. 316
2. Insulators: Polyamide-Imide
3. O-Ring: Fluorocarbon FKM 70 Durometer
4. Ring: PTFE

## WORKING CONDITIONS:

1. Pressure rating: 5000 psi
2. Temperature rating: -40°C to 93°C (-40°F to 200°F)
3. Electrical resistance at 20°C-25°C (68°F-77°F): 10X10<sup>6</sup>Ω at 30V DC

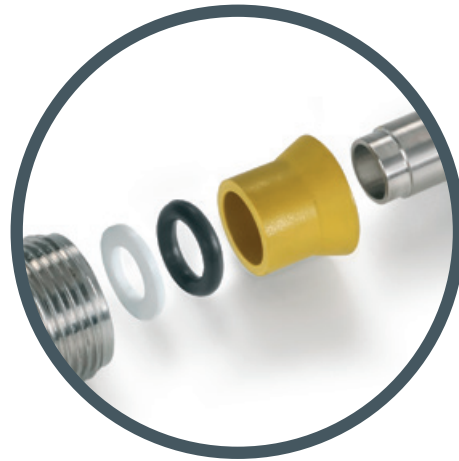
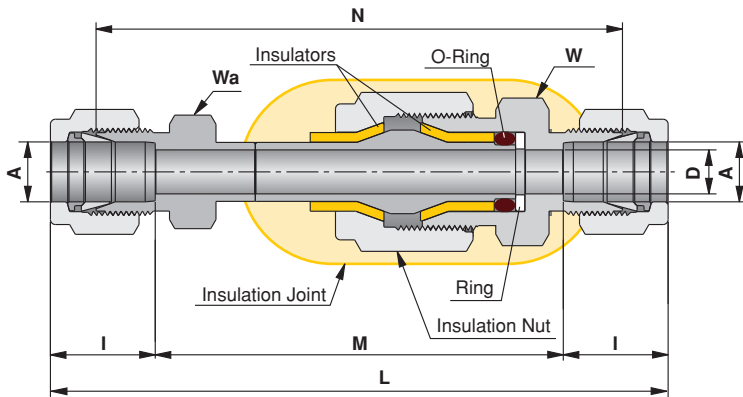

## TUBE (METRIC) TO TUBE (METRIC)

Ordering Information	A Tube O.D.		D		W Hex. Flat	Wa Hex. Flat	M		I		N		L	
	mm	mm	mm	mm	mm	mm	mm	mm	mm	mm	mm	mm	mm	mm
762L _ 10 mm Dielectric	10	7.1	22	18	65.85	17.2	84.85	100.3						
762L _ 12 mm Dielectric	12	7.1	22	22	61.70	22.8	87.10	107.3						

## TUBE (INCH) TO TUBE (INCH)

Ordering Information	A Tube O.D.		D		W Hex. Flat	Wa Hex. Flat	M		I		N		L	
	inch	mm	inch	mm	inch	inch	inch	mm	inch	mm	inch	mm	inch	mm
762L _ 1/8 Dielectric	1/8	3.17	.09	2.28	13/16	1/2	2.56	65.10	50.	12.7	3.07	77.94	3.59	9.11
762L _ 1/4 Dielectric	1/4	6.35	.19	4.80	13/16	1/2	2.57	65.30	60.	15.2	3.19	81.02	3.77	95.8
762L _ 3/8 Dielectric	3/8	9.52	.28	7.11	13/16	5/8	2.59	65.80	66.	16.8	3.34	84.87	3.92	99.6
762L _ 1/2 Dielectric	1/2	12.70	.28	7.11	13/16	13/16	2.37	60.20	90.	22.9	3.37	85.68	4.17	106.0

"D" - Dimension is minimum opening. Dimensions are for reference only and are subject to change without notice.

### TUBE (INCH) TO MALE NPT THREAD

Ordering Information	A Tube O.D.		T (NPT)	D		W Hex. Flat	Wa Hex. Flat	I		N		L	
	inch	mm	inch	inch	mm	inch	inch	inch	mm	inch	mm	inch	mm
768L_ 3/8 X 1/4 Dielectric	3/8	9.52	1/4	.28	7.11	7/8	5/8	.66	16.8	3.44	87.4	3.73	94.7

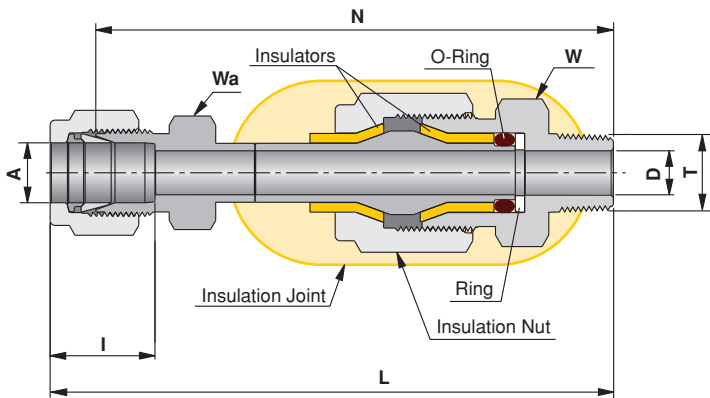

### Assembly Instructions for Dielectric Fittings

1. Hold Hex A (Back-Up) and tighten nut A according to the LET-LOK assembly instructions (see the LET-LOK catalog for more information).
2. Hold Hex B (Back-Up) and tighten nut B according to the LET-LOK assembly instructions.

**CAUTION:** DO NOT LOOSEN the INSULATION NUT and DO NOT USE IT as a BACK UP HEX.

#### NOTES:

1. If the end connection is a Taper Pipe Thread, apply pipe sealant on thread and use Hex A or B as wrenching or as the Backup Hex.
2. For additional types of end connections, please contact your authorized UCT Fluid Solutions representative.

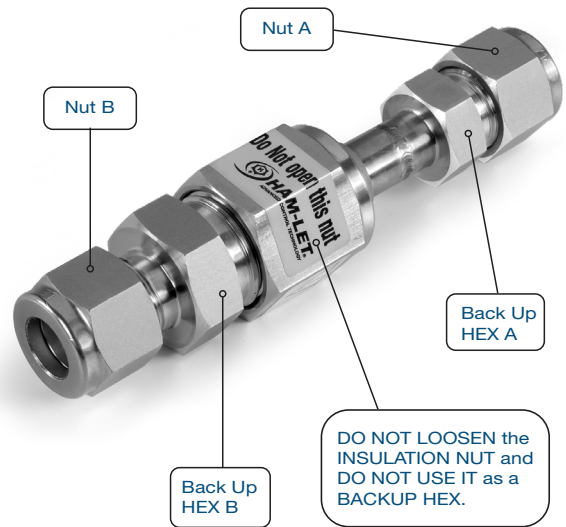

#### Warning!

The system designer and user have the sole responsibility to select products suitable for their special application requirements and to ensure the proper installation, operation and maintenance of the product. Please consider application details, material compatibility and product ratings when making your selection. Improper selection or use of products can cause property damage or personal injury.

“D” - Dimension is minimum opening. Dimensions are for reference only and subject to change without notice.

# ACCESSORIES

## G-RAPID PLUS LOW FRICTION PASTE

### INSTALLATION INSTRUCTIONS FOR LET-LOK FITTINGS

38mm-50mm  
1 1/4"-2"  
30-50mm



1. Close the nut and ferrules on the tube with a hydraulic tool
2. Open and release from the tool
3. Apply the G-Rapid paste on areas A and B
4. Tighten the nut on body 1/2 a turn with a wrench

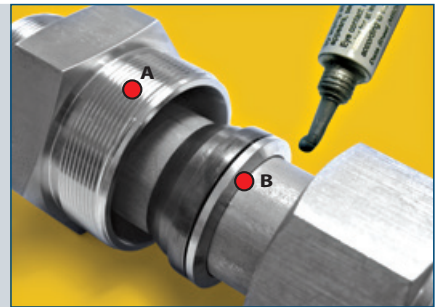

To order:  
use part No. 3900753



### HIGH SAFETY

In applications where severe conditions and high pressure exist, we recommend the following installation procedures:

1. Check that the nut is finger tight
2. Insert the tube (up to the shoulder)
3. Rotate the nut with a wrench until the tube does not rotate freely
4. Mark position of the nut
5. Rotate the nut 1-1/4 turns

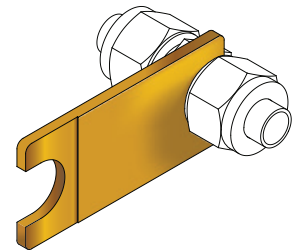

This method ensures that even if the tube O.D. is at the minimum tolerance, the ferrules will be in contact with the tube for the full 1-1/4 rotation.

## LET-LOK GAUGE

SIZE:

GAUGE	AVAILABLE ONLY IN
PART NO. 3900098	(6mm), 3/8", 1/2" (12mm) 1/4"

### ADDITIONAL SIZES:

LET-LOK GAUGE	LET-LOK SIZE
PART NO. 3901508	No-GO Gauge 1/16
3901509	No-GO Gauge 1/8"-2-3 mm
3901510	No-GO Gauge 3/16"- 4 mm
3901513	No-GO Gauge 5/16"- 8 mm
3902398	No-GO Gauge 8 mm
3901511	No-GO Gauge 10 mm
3901247	No-GO Gauge 5/8"-14-15-16 mm
3901246	No-GO Gauge 3/4"-18 mm
3901512	No-GO Gauge 7/8"-20-22 mm
3901245	No-GO Gauge 1"-25 mm

"D" - Dimension is minimum opening. Dimensions for reference only and subject to change without notice.

# ACCESSORIES



## STAINLESS STEEL TUBE CUTTER

Ordering Information	Capacity	
	inch	mm
Tube Cutter	3/16-1	5-25
Replacement Wheel	3/16-1	5-25



## REAMERS, DEBURRING TOOLS

Ordering Information	Capacity
In.Out.Reamer 1/4"-1 1/4"	1/4" (5mm) through 1 1/4" (36mm)
In.Out.Reamer 1/2"-2"	1/2" (12mm) through 2" (54mm)



## LEVER TUBE BENDERS

Ordering Information	Capacity	
	Tube Size	Bend Radius
Lever Bender 3/16	3/16"	5/ 8"
Lever Bender 1/4	1/4"	5/8"
Lever Bender 5/16	5/16"	15/16"
Lever Bender 3/8	3/8"	15/16"
Lever Bender 1/2	1/2"	1 1/2"
Lever Bender 6	6mm	16mm
Lever Bender 8	8mm	24mm
Lever Bender 10	10mm	24mm
Lever Bender 12	12mm	38mm



# PREASSEMBLY TOOL

In constrained installation areas, LET-LOK® fittings can be assembled with the preassembly tool and another second step on the system.

PART NO.	LET-LOK SIZE
3902419	PREASSEMBLY TOOL 1/8
3901658	PREASSEMBLY TOOL 1/4
3901659	PREASSEMBLY TOOL 3/8
3901660	PREASSEMBLY TOOL 1/2
3902719	PREASSEMBLY TOOL 5/8
3902402	PREASSEMBLY TOOL 6MM
3902420	PREASSEMBLY TOOL 8MM
3902421	PREASSEMBLY TOOL 10MM
3902422	PREASSEMBLY TOOL 12MM
3902720	PREASSEMBLY TOOL 14MM
3902721	PREASSEMBLY TOOL 15MM
3902538	PREASSEMBLY TOOL 16MM



## Instructions for using Preassembly Tool 6mm-25mm, 1/4”-1”

1. Assemble HAM-LET ferrules and nut on the Preassembly Tool. Tighten the nut to finger tight position.
2. Insert the tube through the nut and ferrules until the tube touches the bottom (shoulder).
3. From the finger tight position, rotate the nut 1-1/4 turns (450°).
4. Release the nut from the Preassembly Tool; pull out the tube with the ferrules swaged into the tube.
5. Insert tube with swaged ferrules into the fitting body.
6. Tighten the nut to the finger tight position.
7. To assemble on the fitting, use a wrench to tighten the nut to the original position. An increase of torque will be felt from this point turn the wrench slightly. Tightening to the original position depends on the tube size. A large tube size will need more tightening than a small size, and the wall thickness has some effect on the tightening.

### NOTE:

1. When using the Preassembly Tool, make sure the tool is free of damage and is clean prior to use.
2. Usage of the Preassembly Tool is limited. After permanent use please send tool to UCT Fluid Solutions for evaluation.
3. Soft tubing and tubing at the maximum diameter tolerance can cause the tube to stick to the Preassembly Tool. In order to remove the stuck tube, please rock the tube back and forth until the tube is released from the tool.

## Instructions for using Preassembly Tool 2mm-4mm, 1/8”-3/16”

1. Assemble HAM-LET ferrules and nut on the Preassembly Tool, tighten the nut to the finger tight position.
2. Insert the tube through the nut and ferrules until the tube touches the bottom (shoulder).
3. From the finger tight position, rotate the nut 3/4 of a turn (270°).
4. Release the nut from the Preassembly Tool; pull out the tube with the ferrules swaged into the tube.
5. Insert tube with swaged ferrules into the fitting body.
6. Tighten the nut to the finger tight position.
7. To assemble on the fitting, use a wrench to tighten the nut to the original position. An increase of torque will be felt, from this point turn the wrench slightly.



# TUBE HOLDERS

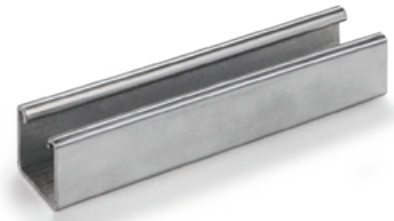
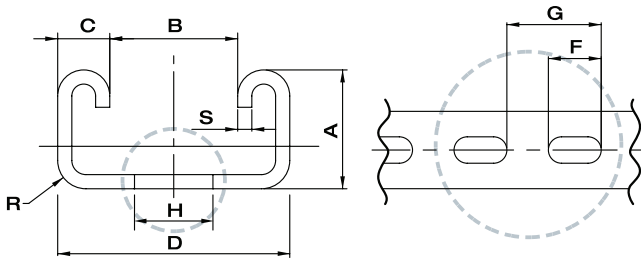

## PERFORATED STAINLESS STEEL TUBE HOLDER SUPPORT

HL / PN	A, mm	B, mm	C, mm	D, mm	L, m	S, mm	R, mm	F, mm	G, mm	H, mm
P-L-G	41.0	22.6	9.2	41.0	6.0	2.5	5.0	28.0	50.0	14.0
P-S-G	21.0	22.6	9.2	41.0	6.0	2.5	5.0	28.0	50.0	14.0
P-L-Z	41.0	22.6	9.2	41.0	6.0	2.5	5.0	28.0	50.0	14.0
P-S-Z	21.0	22.6	9.2	41.0	6.0	2.5	5.0	28.0	50.0	14.0

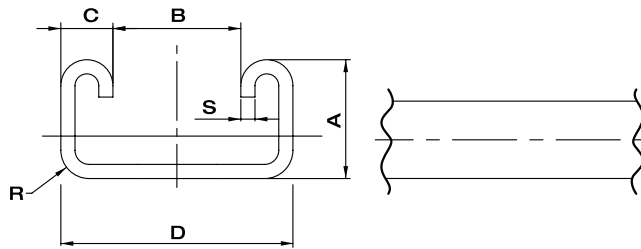

## BLANK STAINLESS STEEL TUBE HOLDER SUPPORT

HL / PN	A, mm	B, mm	C, mm	D, mm	L, m	S, mm	R, mm
B-L-G	41.0	22.6	9.2	41.0	6.0	2.5	5.0
B-S-G	21.0	22.6	9.2	41.0	6.0	2.5	5.0
B-L-Z	41.0	22.6	9.2	41.0	6.0	2.5	5.0
B-S-Z	21.0	22.6	9.2	41.0	6.0	2.5	5.0

## ORDERING INFORMATION

### Perforation

**P** = Perforated  
**B** = Blank

### Size

**S** = Small  
**L** = Large

### Finish Type

**Z** = Zink Coating Yellow  
**G** = Hot dip galvanized

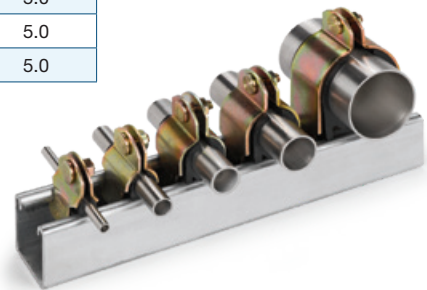

## CLAMPED TUBE HOLDERS

HL / PN	A, inch	B, mm	C, mm	D, mm
CTH-1/4	1/4	5.7	29.2	18.2
CTH-3/8	3/8	7.3	32.2	23.0
CTH-1/2	1/2	7.8	36.6	23.7
CTH-5/8	5/8	22.6	41.7	25.0
CTH-3/4	3/4	13.8	48.3	32.7
CTH-7/8	7/8	22.6	51.2	34.0
CTH-1	1	16.8	53.8	40.8
CTH-1 1/8	1-1/8	22.6	59.4	40.9
CTH-1 5/8	1-5/8	22.6	71.8	58.3
CTH-2	2	30.4	82.0	64.1

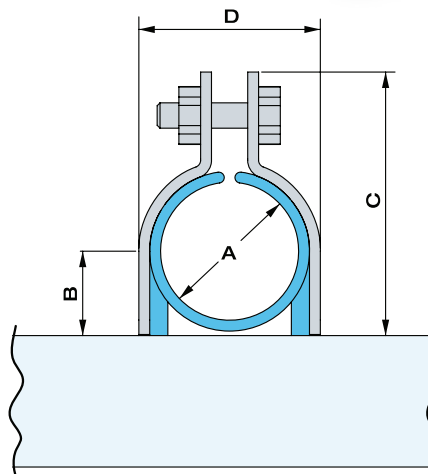

# STOP COLLAR

LET-LOK®		D	
inch	inch	mm	
1/4	.69	17.5	
3/8	.84	20.6	
1/2	1.10	27.0	
3/4	1.31	33.3	
1	1.68	42.7	

## Assembly Instructions - Stop Collar

1. Remove the nut and ferrules from the fitting
2. Insert the stop collar
3. Assemble the nut and ferrules until finger tight
4. Make up the fitting until the stop collar no 98 guaranteed that the fitting is assembled correctly.

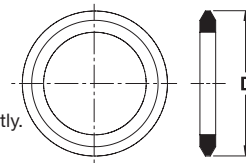

## ORDERING INFORMATION FOR ASSEMBLED STOP COLLAR (WITH FITTING)

768L	SS	1/4	1/4	SC
<b>Fitting Type</b>	<b>SS = Stainless Steel 316</b>	<b>Tube O.D.</b>	<b>1/4 NPT</b>	<b>Stop Collar</b>
Male LET-LOK® Connector Male End Connection	B = Brass M = Alloy 400 HC = Alloy C-276	The O.D. size is always the first to be described.	X	

Fitting Material

## HOW TO ORDER STOP COLLAR ONLY

STOP COLLAR	1/4
<b>Stop Collar</b>	<b>Tube O.D.</b>
	The O.D. size is always the first to be described.